

NANO 11

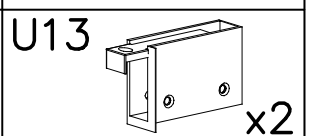

I

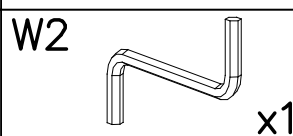
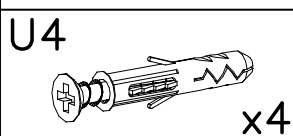
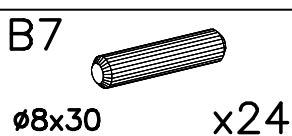
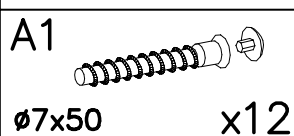
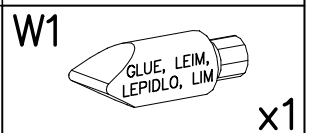
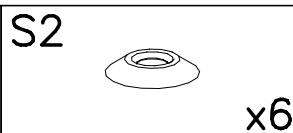
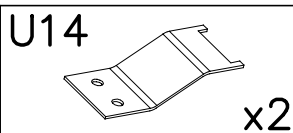
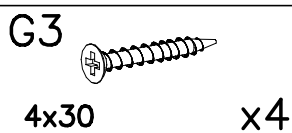
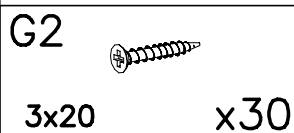
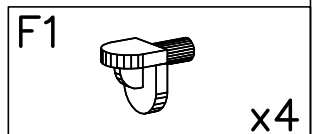
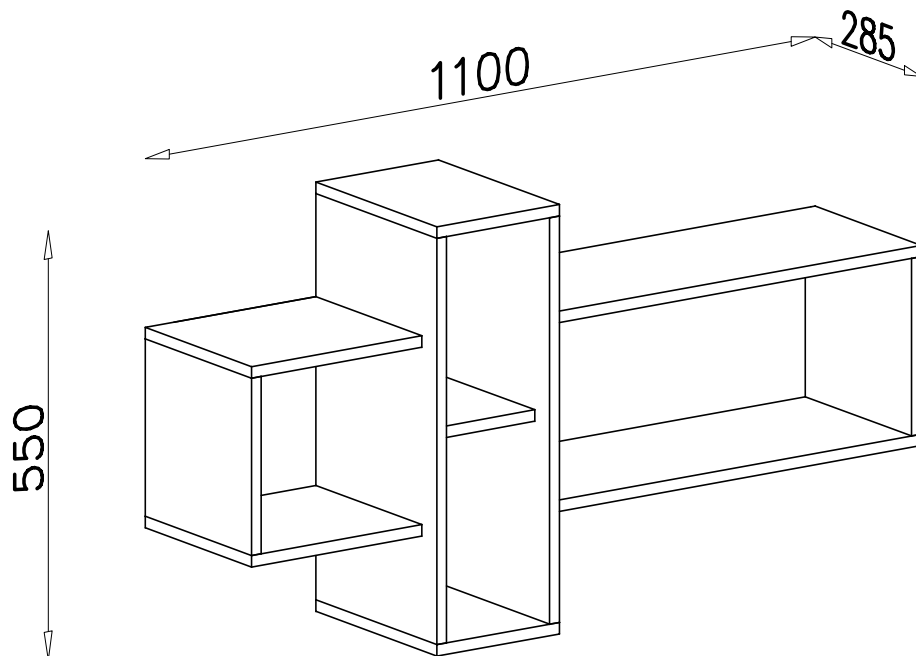
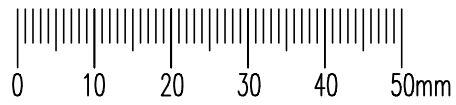
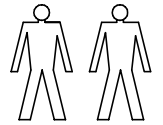
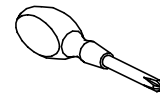
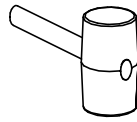
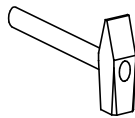
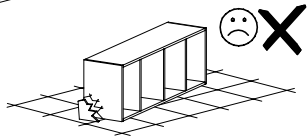
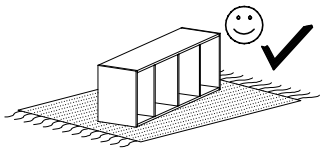
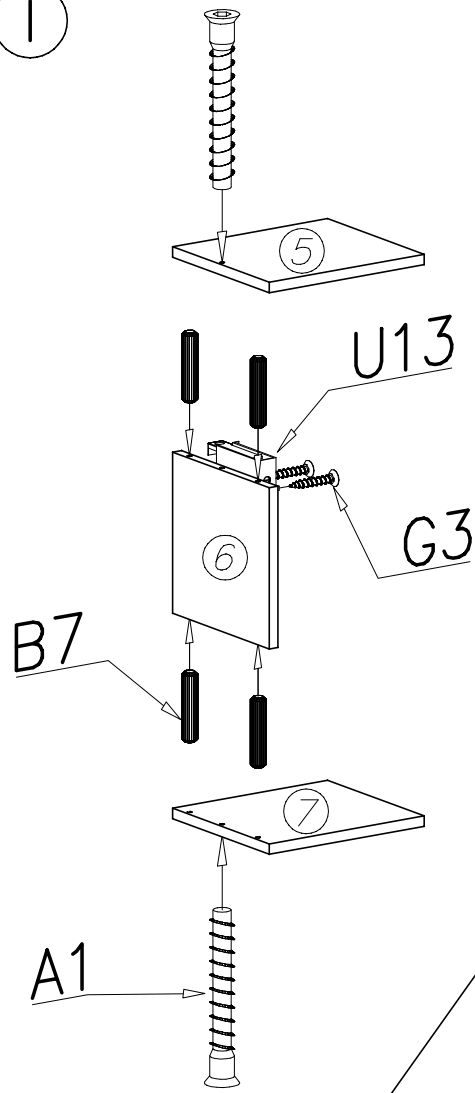

II

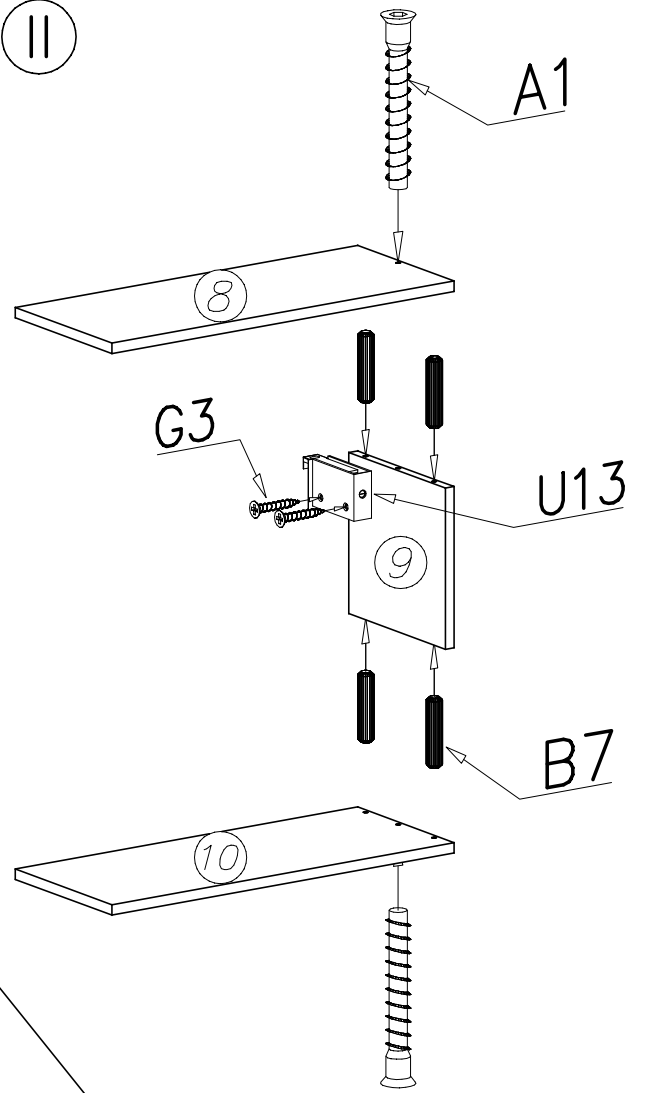

III

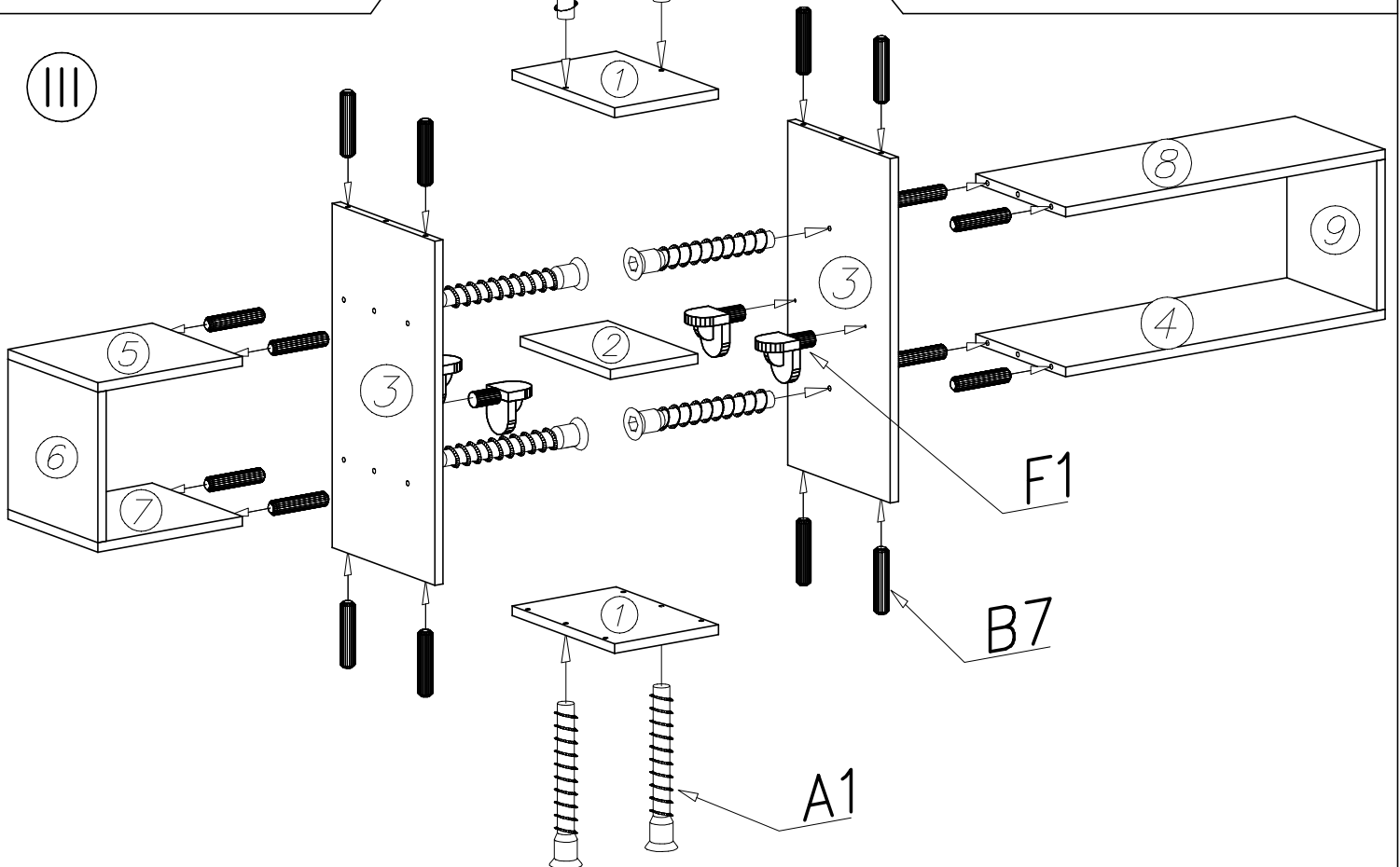

IV

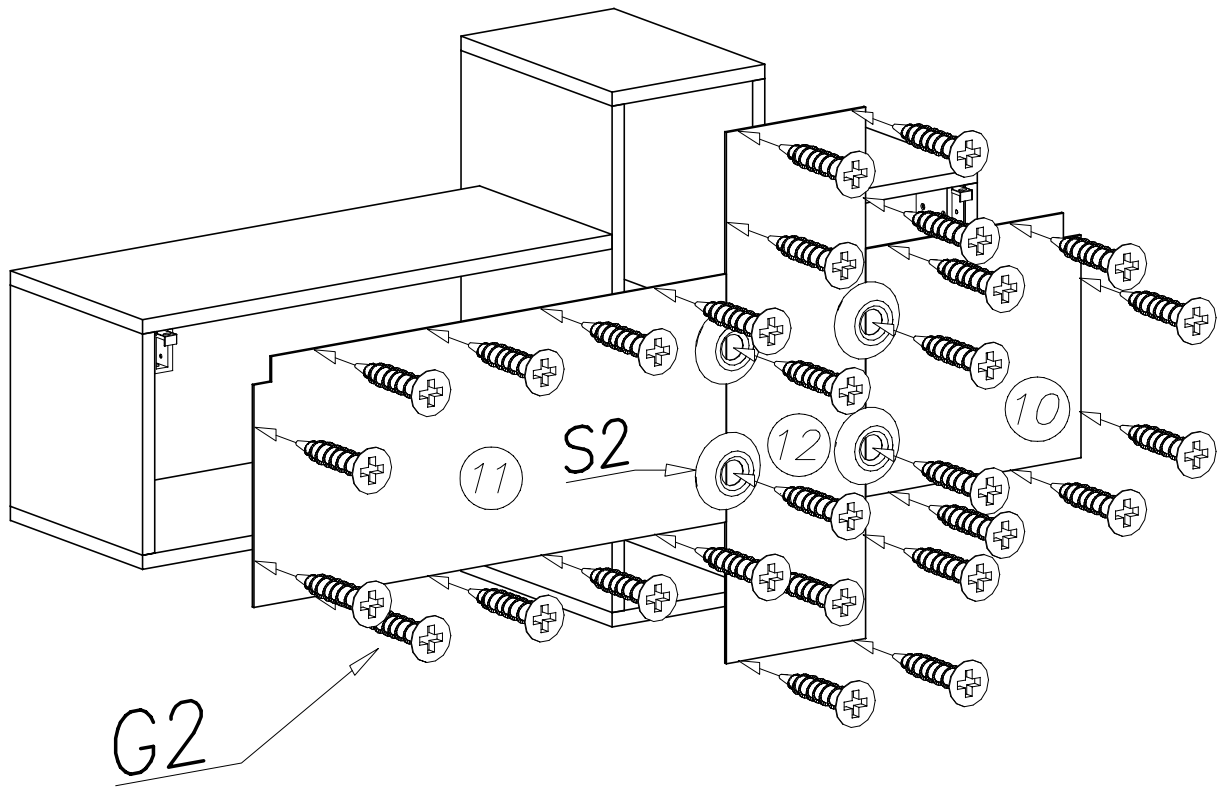

V

