

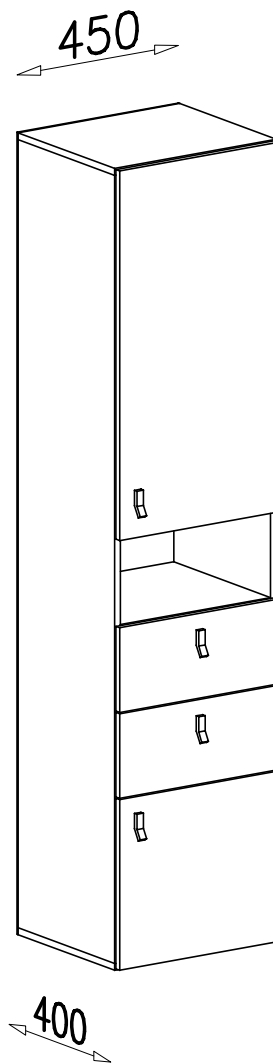

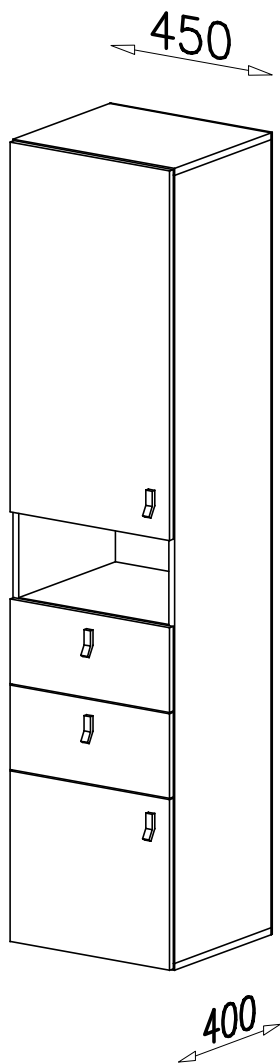

# PLANET PL 4L/P

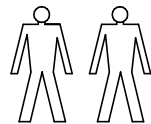
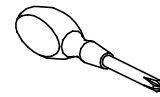
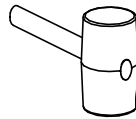
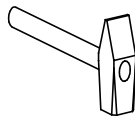
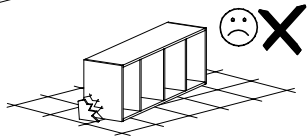
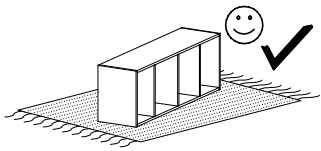

**E37**  x4

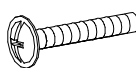
**W1**  x2  
GLUE, LEIM, LEPIDLO, LIM

**N13**  x8  
4x20

**D3**  x4  
PZ35PR

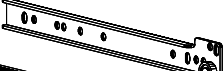
**H7**  x2  
350mm

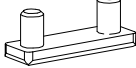
**P3**  x4

**G4**  x20  
4x16

**G2**  x45  
3x20

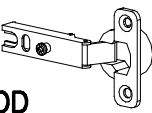
**C4**  x4  
Z350D

**G10**  x8  
6x13

**A1**  x8  
ø7x50

**B7**  x32  
ø8x30

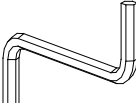
**W2**  x1

**F1**  x8

**G10**  x8  
6x13

1

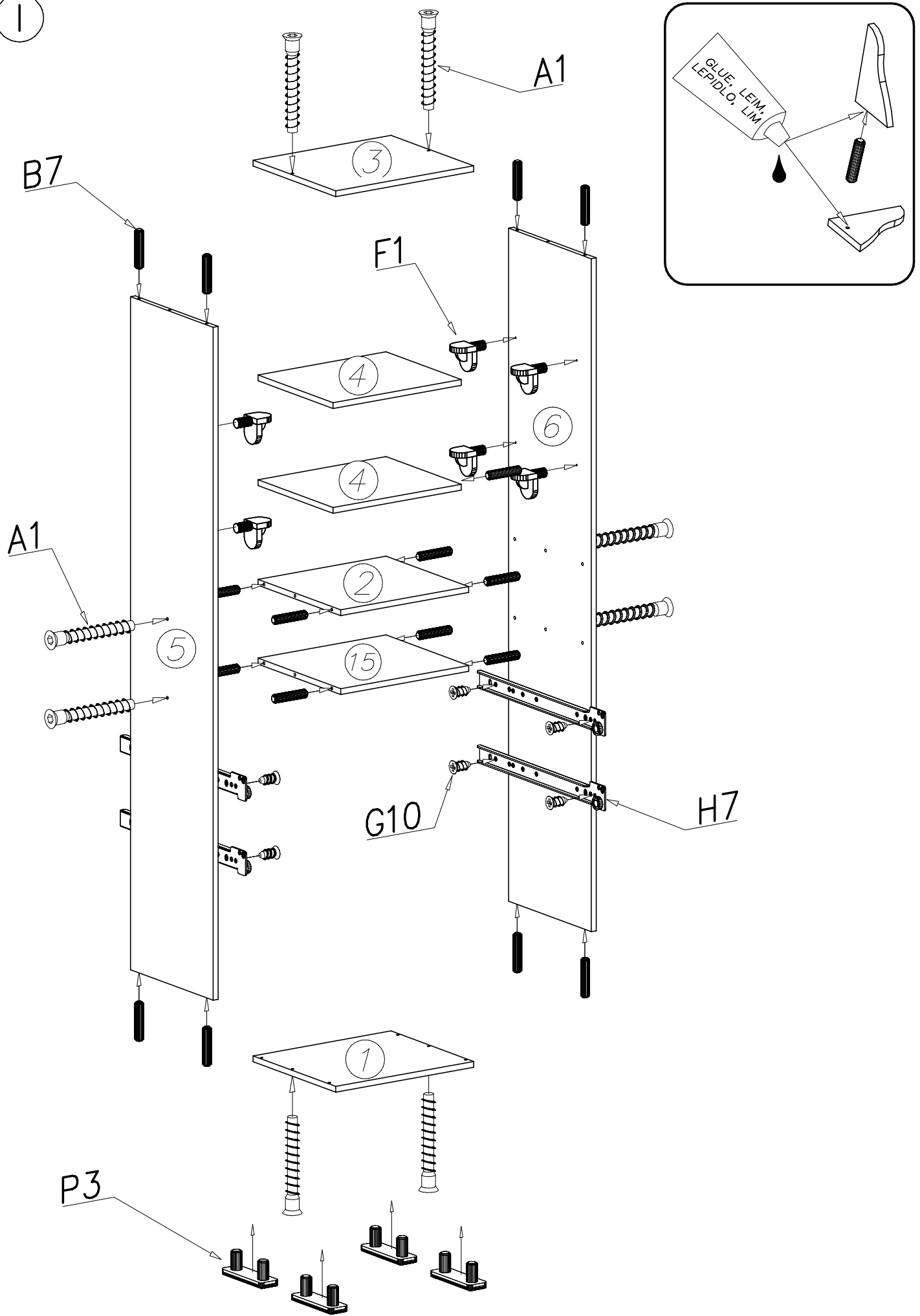

II

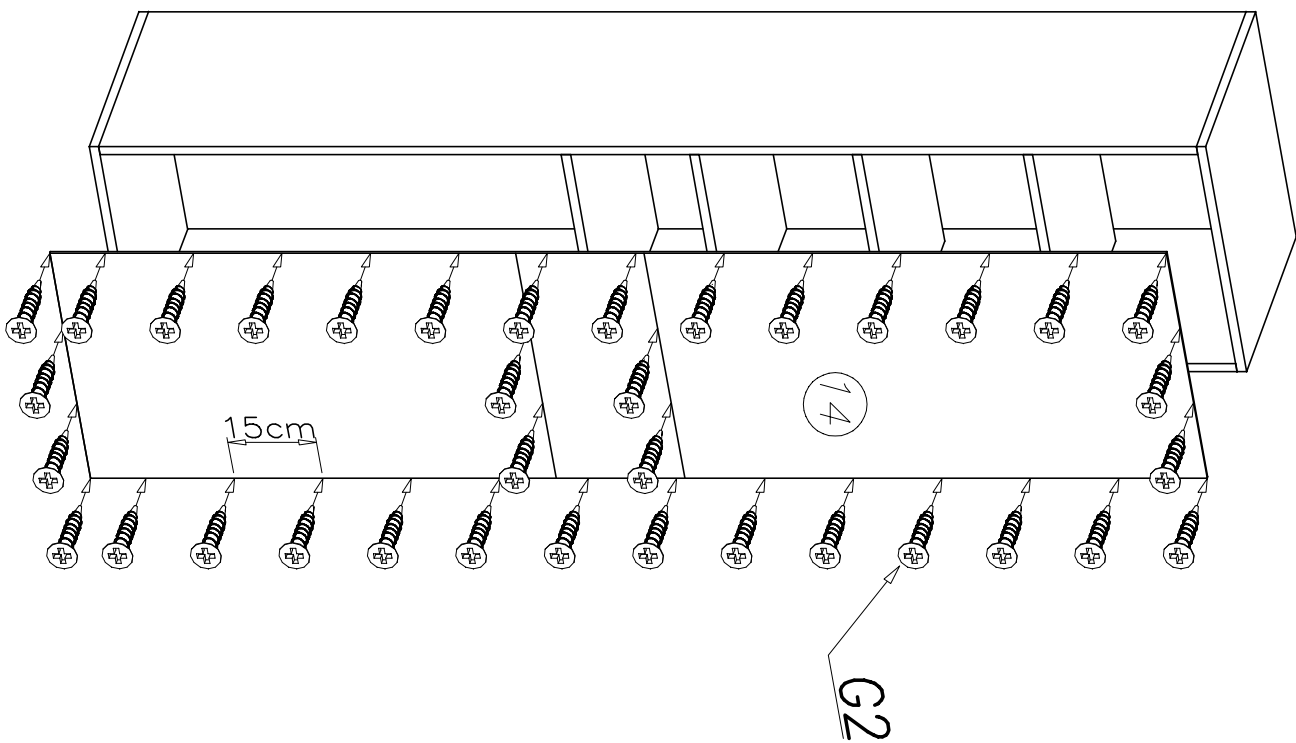

III

