

# INDIANAPOLIS 4

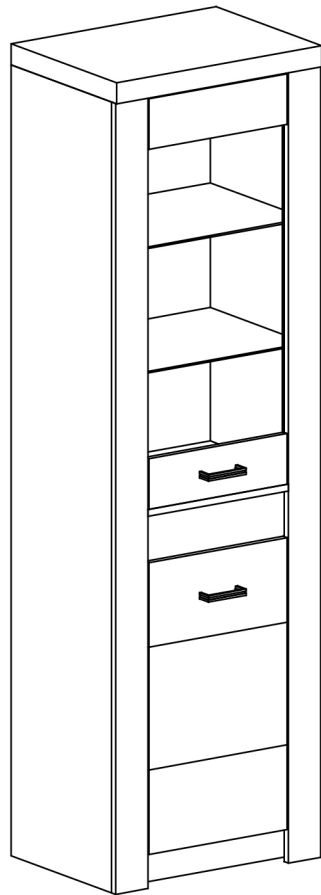

Nr	D[mm]	S[mm]	G[mm]	
1	527	422	16	1
2	1870	403	16	1
3	1870	403	16	1
4	527	403	16	1
5	527	80	16	1
6	526	123	16	1
7	1800	550	2,5	1
8	526	350	4	2
9	1870	80	16	1
10	1870	80	16	1
11	560	422	48	1
12	527	380	16	1
13	782	395	4	1
14	395	120	16	1
15	395	120	16	1
16	665	395	16	1

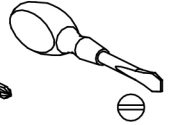
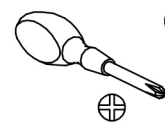
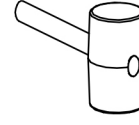
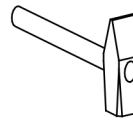
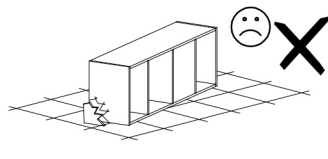
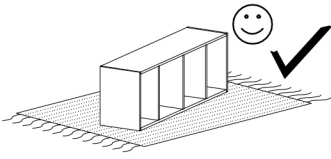
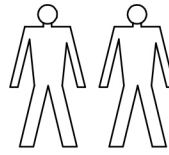
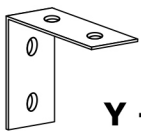

**Y - 1 St.**

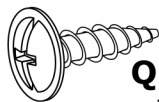

**Q - 2 St.**  
3,5x16 mm



**X1 - 12 St.**



**X2 - 8 St.**



**X3 - 2 St.**  
Ø5 mm

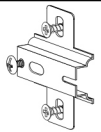

**C - 4 St.**

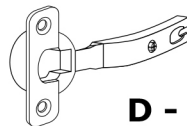

**D - 4 St.**



**R - 6 St.**

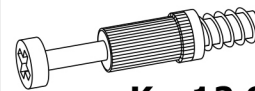

**K - 12 St.**

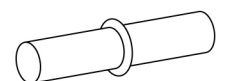

**P - 4 St.**

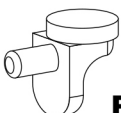

**F - 10 St.**

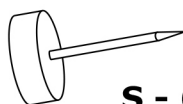

**S - 6 St.**



**U - 2 St.**

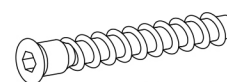

**A - 8 St.**

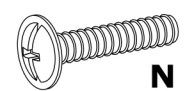

**N - 4 St.**  
4x22 mm



**E - 35 St.**

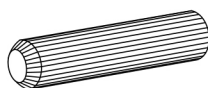

**B - 24 St.**

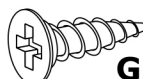

**G - 14 St.**  
3,5x16 mm

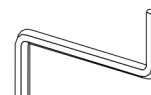

**Z - 1 St.**



**L - 12 St.**

I

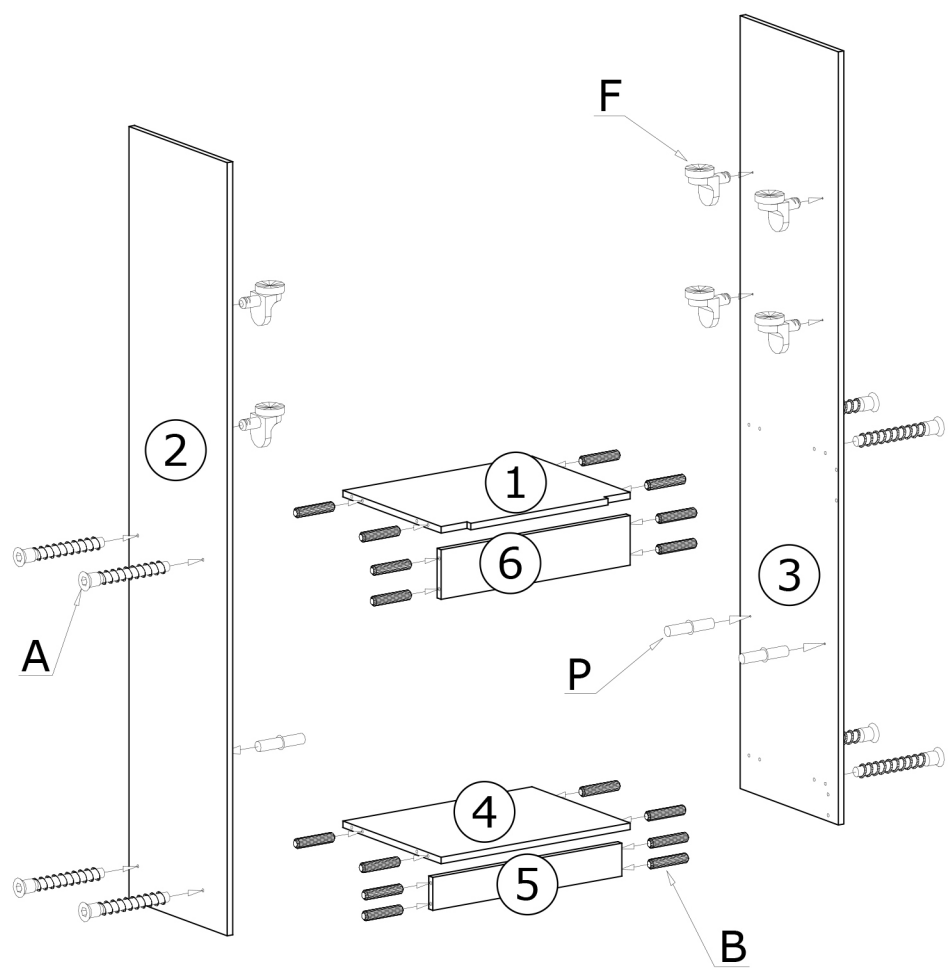

II

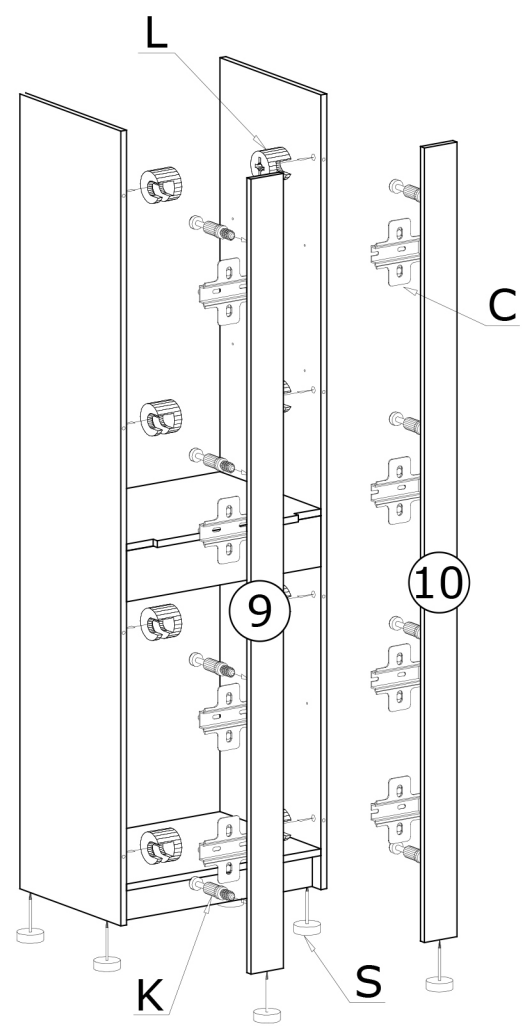

III

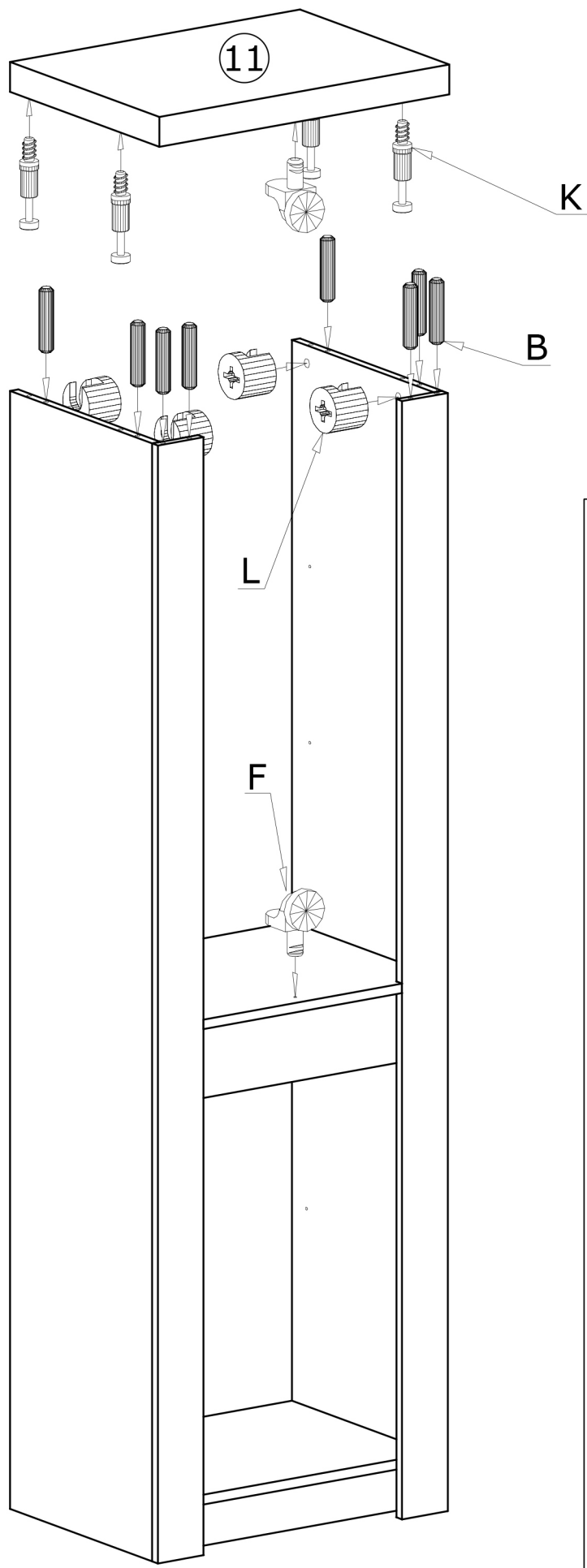

IV

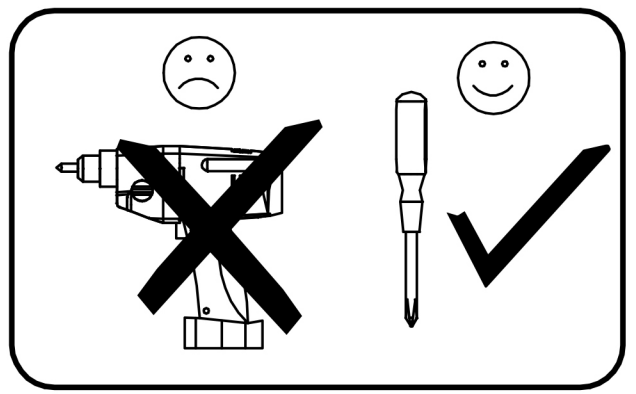
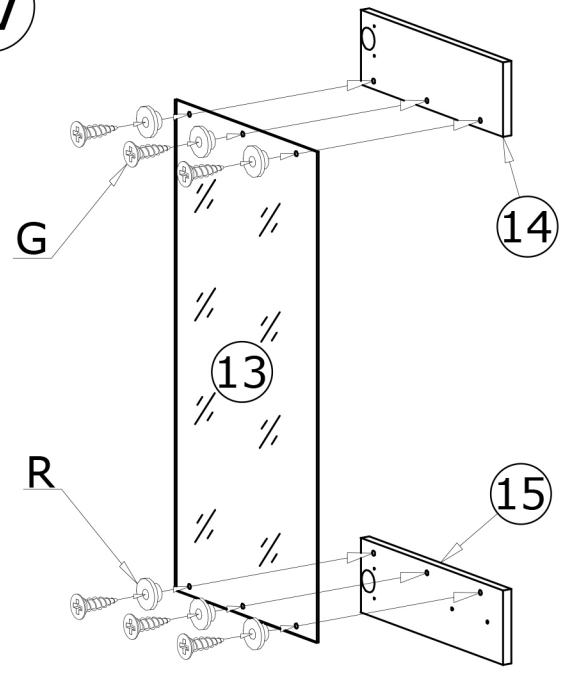

V

35X 

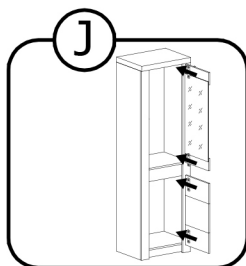
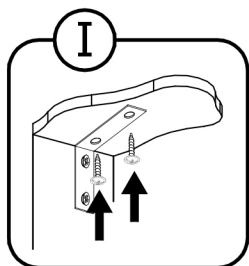
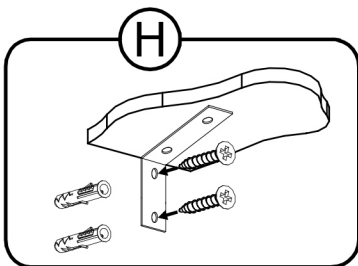
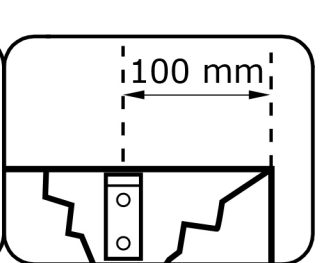
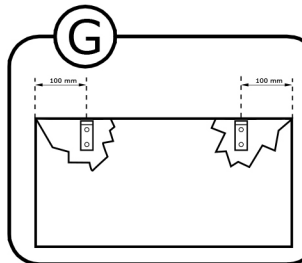
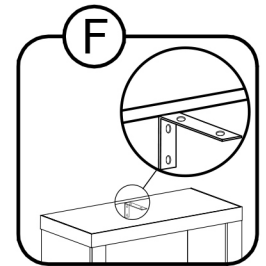
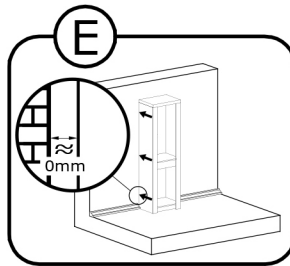
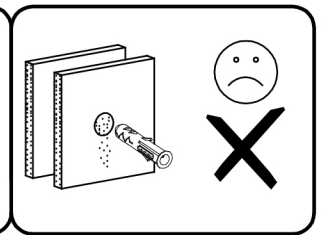
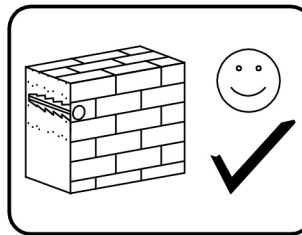
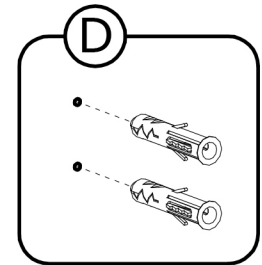
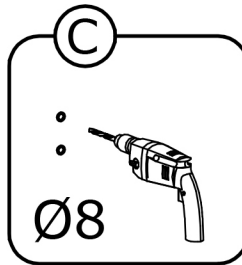
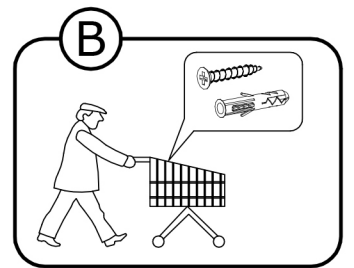
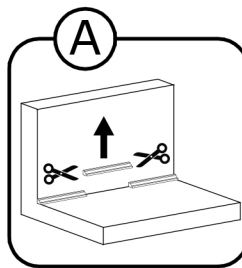
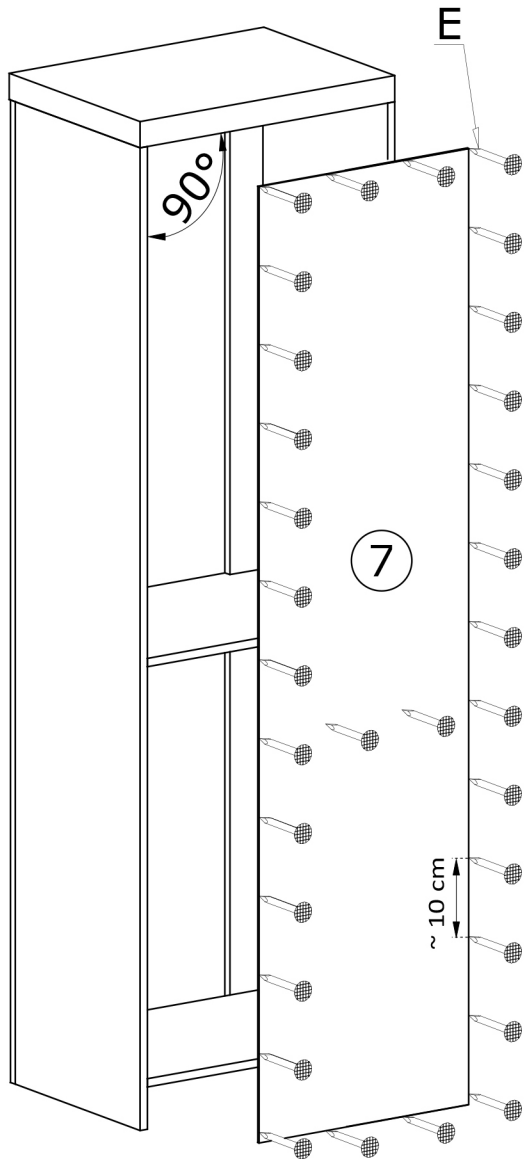

VI

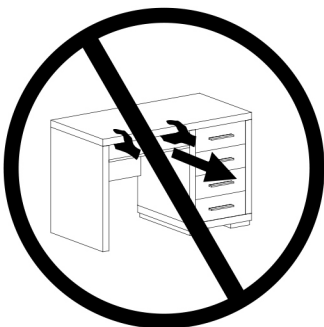
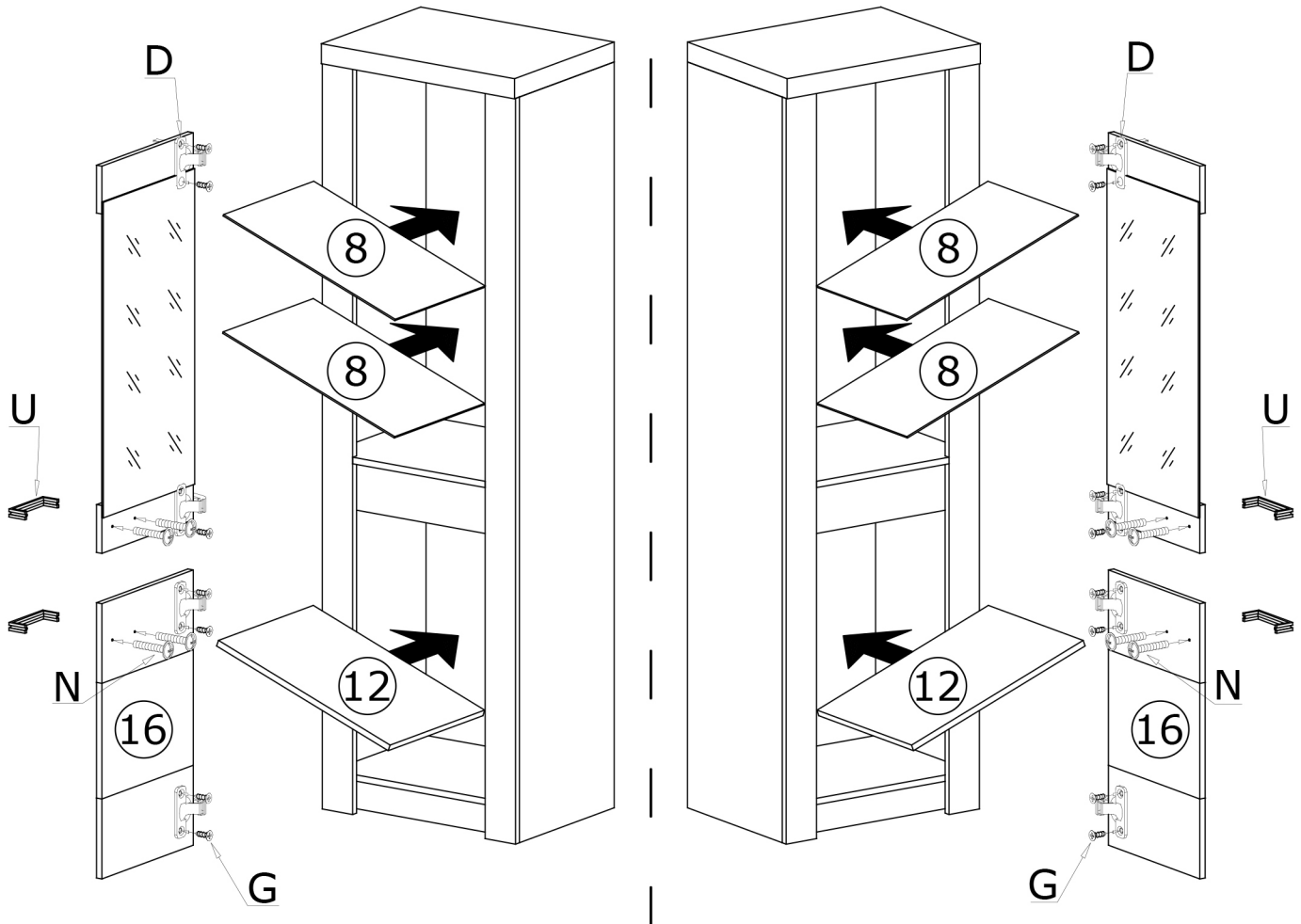
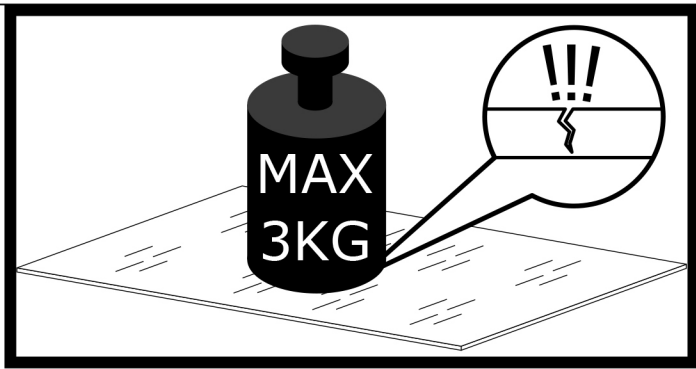

PL

**UWAGA!!!**

MONTOWANIE USZKODZONYCH ELEMENTÓW POWODUJE UTRATĘ GWARANCJI

**UWAGA!!!**

MEBEL ZAWIERA ELEMENTY DREWNIANE

W PRZYPADKU REKLAMACJI PROSZĘ PODAĆ NUMER PAKOWACZA ZNAJDUJĄCY SIĘ NA KARTONIE  
ODCIĘŃ DREWNA I UKŁAD SŁOI MOGĄ NIEZNACZNIE ODBIEGAĆ  
OD PREZENTOWANYCH NA ZDJĘCIACH KATALOGOWYCH

CZ

**UPOZORNĚNÍ!!!**

MONTÁŽ POŠKOZENÝCH KOMPONENTŮ RUŠÍ PLATNOU ZÁRUKU

**UPOZORNĚNÍ!!!**

NÁBYTEK OBSAHUJE DŘEVĚNÉ PRVKY

V PŘÍPADĚ REKLAMACE UVEĎTE PROSÍM ČÍSLO BALIČE, KTERÉ NAJDETE NA KRABICI  
ODSTÍN A KRESBA DŘEVA SE MOHOU VÝRAZNĚ LIŠIT  
OD TĚCH ZOBRAZENÝCH NA KATALOGOVÝCH FOTOGRAFIÍCH

DE

**BEACHTUNG!!!**

DER EINBAU BESCHÄDIGTER KOMPONENTEN SCHLIESST EINE GÜLTIGE GEWÄHRLEISTUNG AUS

**BEACHTUNG!!!**

MÖBEL ENTHALTEN HOLZELEMENTE

IM FALL EINER REKLAMATION GEBEN SIE BITTE DIE PAKETNUMMER AN,  
DIE SIE AUF DEM KARTON FINDEN  
HOLZSCHATTIERUNG UND HOLZZEICHNUNG KÖNNEN UNTERSCHIEDLICH  
VON DEN AUF DEN KATALOGFOTOS GEZEIGTEN ABWEICHEN

HR

**PAŽNJA!!!**

INSTALACIJA OŠTEĆENIH KOMPONENTI ZA POSLJEDICU IMA GUBITAK JAMSTVA

**PAŽNJA!!!**

NAMJEŠTAJ SADRŽI DRVENE ELEMENT

U SLUČAJU REKLAMACIJE, MOLIMO NAVESTI BROJ PAKIRANJA KOJI SE NALAZI NA KUTIJI  
NIJANSA DRVETA I RASPORED GODOVA MOGU MINIMALNO  
ODUDARATI OD ONIH NA KATALOŠKIM FOTOGRAFIJAMA

HU

**FIGYELEM!!!**

SÉRÜLT ALKATRÉSZEK BEÉPÍTÉSE ESETÉN A GARANCIA ÉRVÉNYÉT VESZTI

**FIGYELEM!!!**

A BÚTOROK FA ELEMÉKET TARTALMAZNAK

REKLAMÁCIÓ ESETÉN KÉRJÜK, ADJA MEG A DOBOZON TALÁLHATÓ CSOMAGOLÁSI SZÁMOT  
A FA ÁRNYALATA ÉS A CSOMÓK ELRENDEZÉSE  
JELENTŐSEN ELTÉRHET A KATALÓGUSBAN SZEREPLŐ KÉPEKTŐL

SK

**UPOZORNENIE!!!**

INŠTALÁCIU POŠKODENÝCH KOMPONENTOV SA RUŠÍ ZÁRUKA

**UPOZORNENIE!!!**

NÁBYTOK OBSAHUJE DREVENÉ PRVKY

V PRÍPADE REKLAMÁCIÍ UVEĎTE ČÍSLO BALENIA NÁJDENÉ NA KRABICI  
ODTIEŇ DREVA A USPORIADANIE UZLOV  
SA MÔŽE VÝRAZNE LIŠIŤ OD KATALÓGOVÝCH OBRÁZKOV

SR

**PAŽNJA!!!**

MONTAŽA OŠTEĆENIH DELOVA DOVODI DO GUBITKA GARANCIJE

**PAŽNJA!!!**

NAMEŠTAJ SADRŽI DRVENE DELOVE

U SLUČAJU REKLAMACIJA MOLIMO DA DOSTAVITE PAKER BROJ KOJI SE NALAZI NA KARTONU  
NIJANSA BOJE DRVETA I RASPORED SLOJEVA MOGU NEZNATNO  
DA SE RAZLIKUJU OD PREZENTOVANIH NA SLIKAMA U KATALOGU