

CAMPARI WNPP 6/36

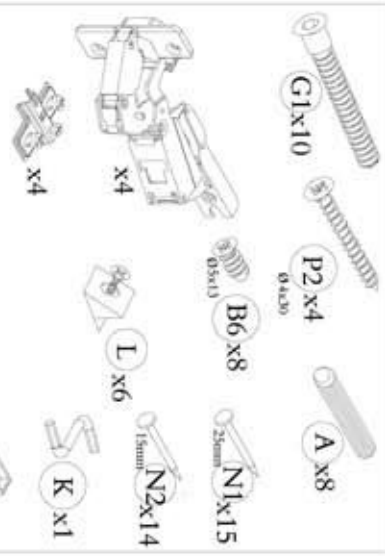

1.

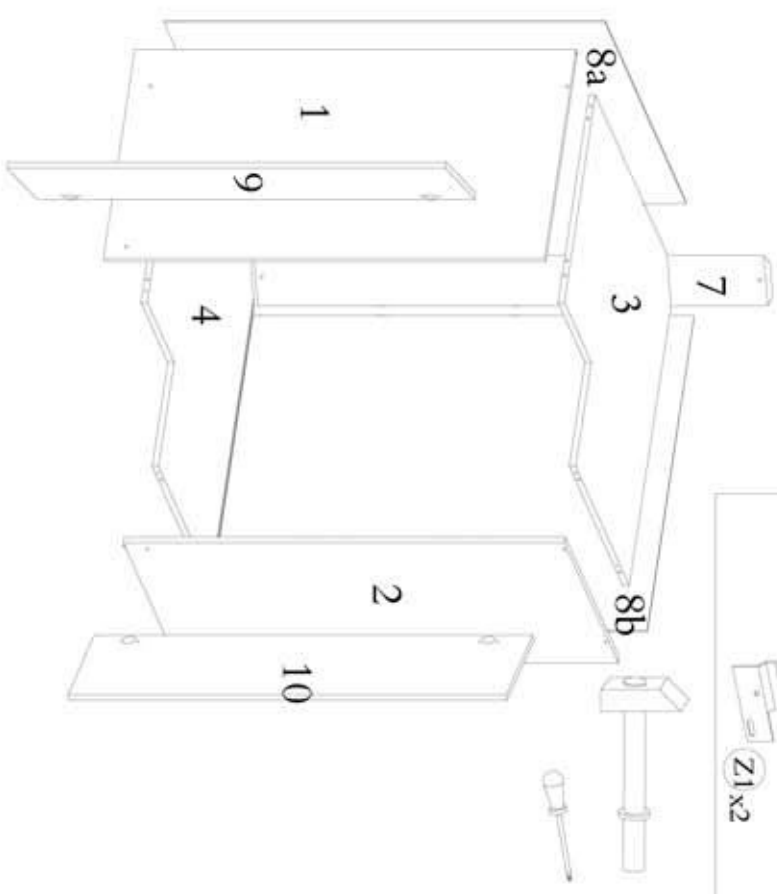

2.

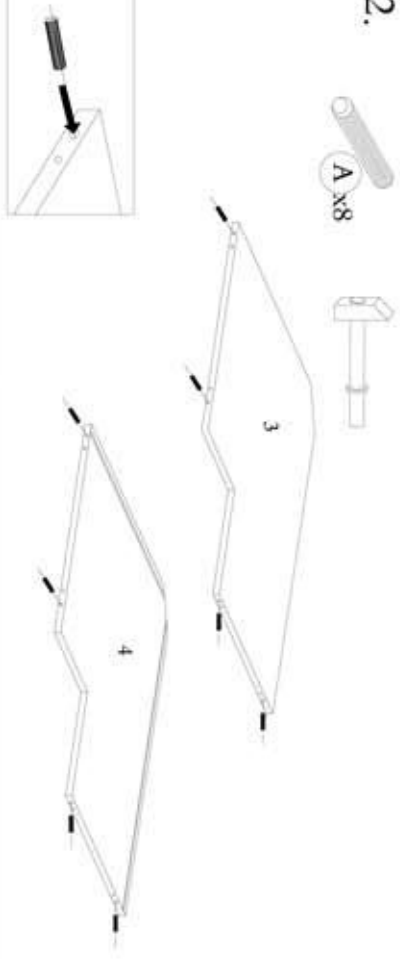

3.

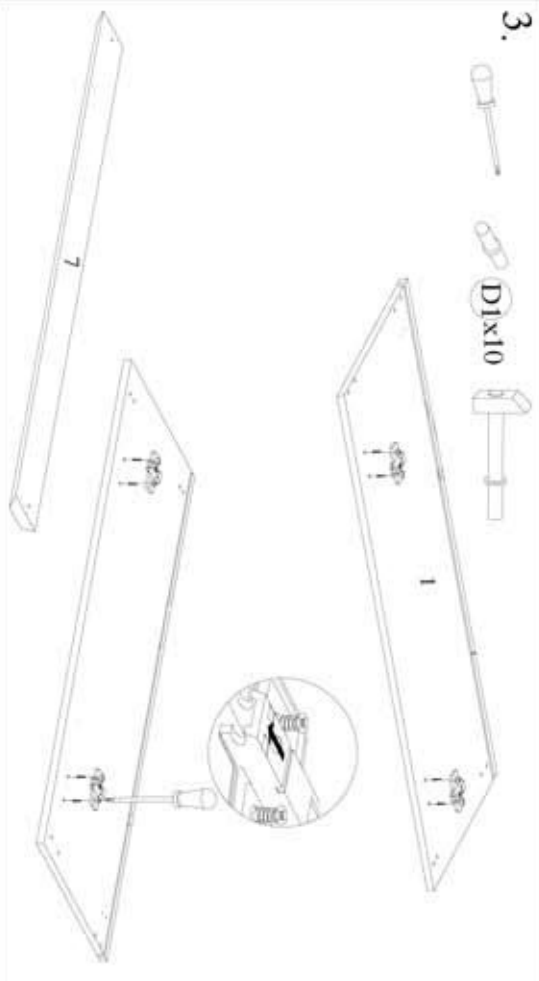

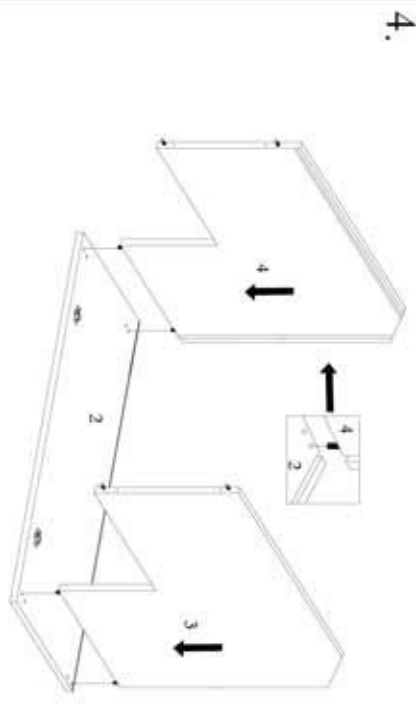

4.

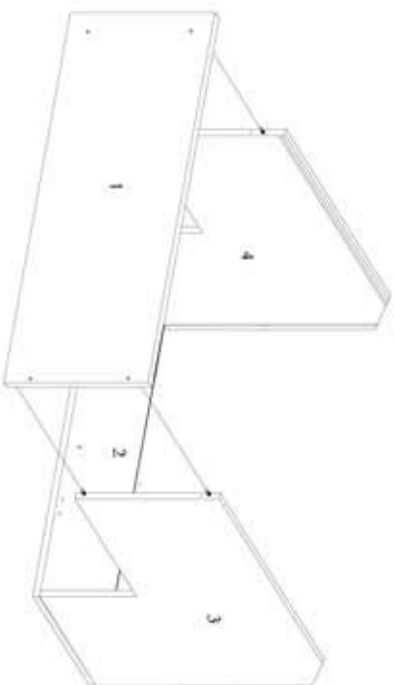

5.1



5.2  G2x4  G1x4

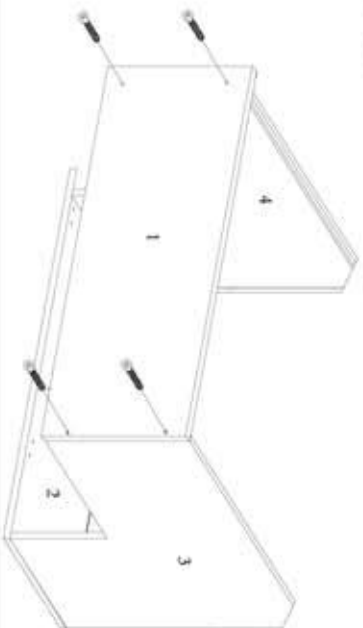

5.3

 G2x4  G1x4

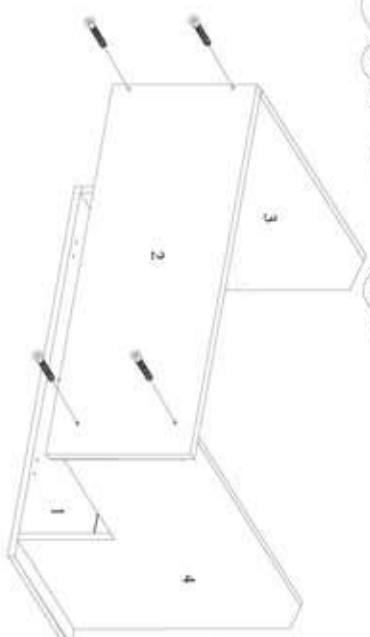

5.4

 G2x2  G1x2

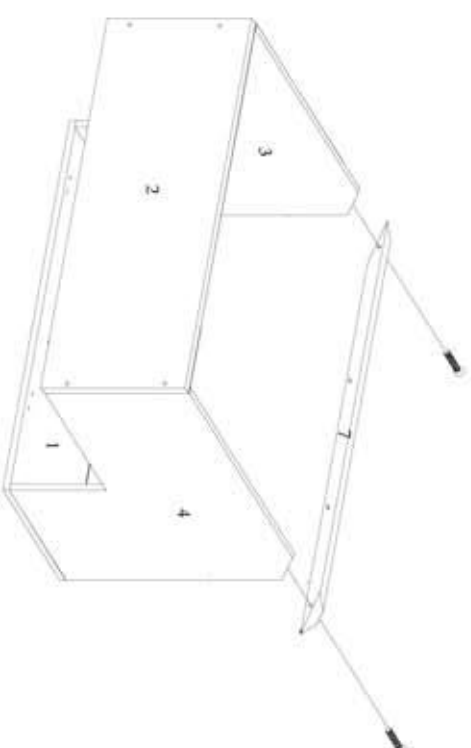

6.   L/x6  N1x15 

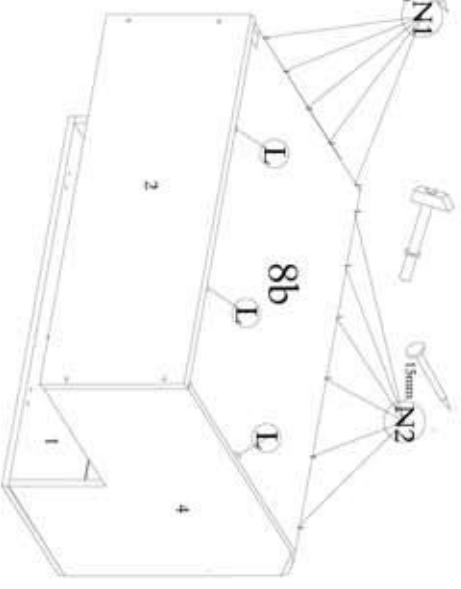
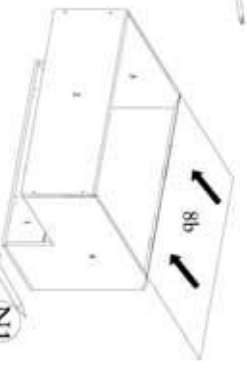
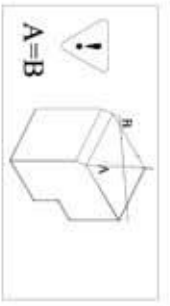

6.1

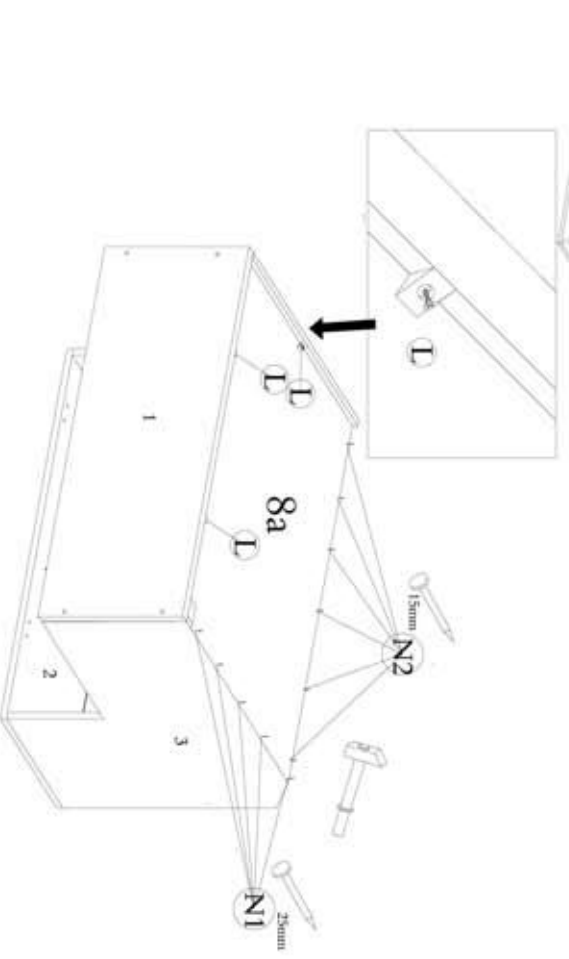

7. 

  B3x4  Ø5x13  B6 x8

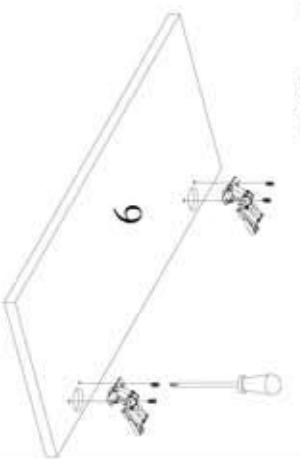
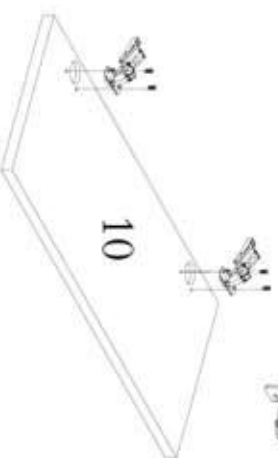

8.

  p2 x4
Ø4x30

  p1 x1

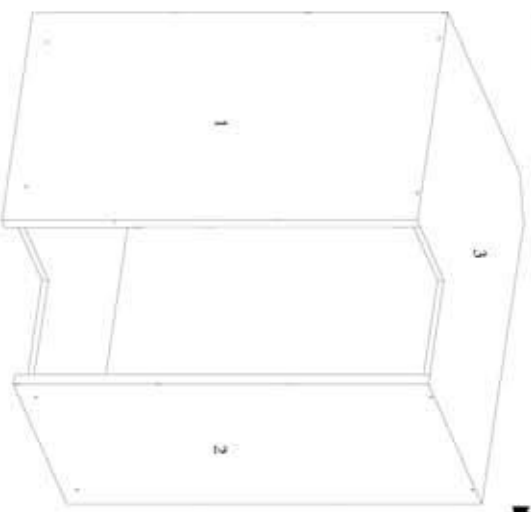
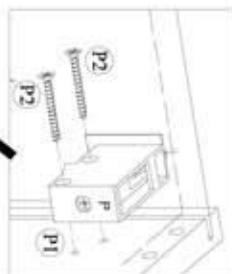
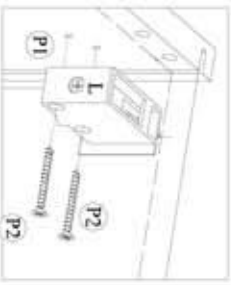

9.

