

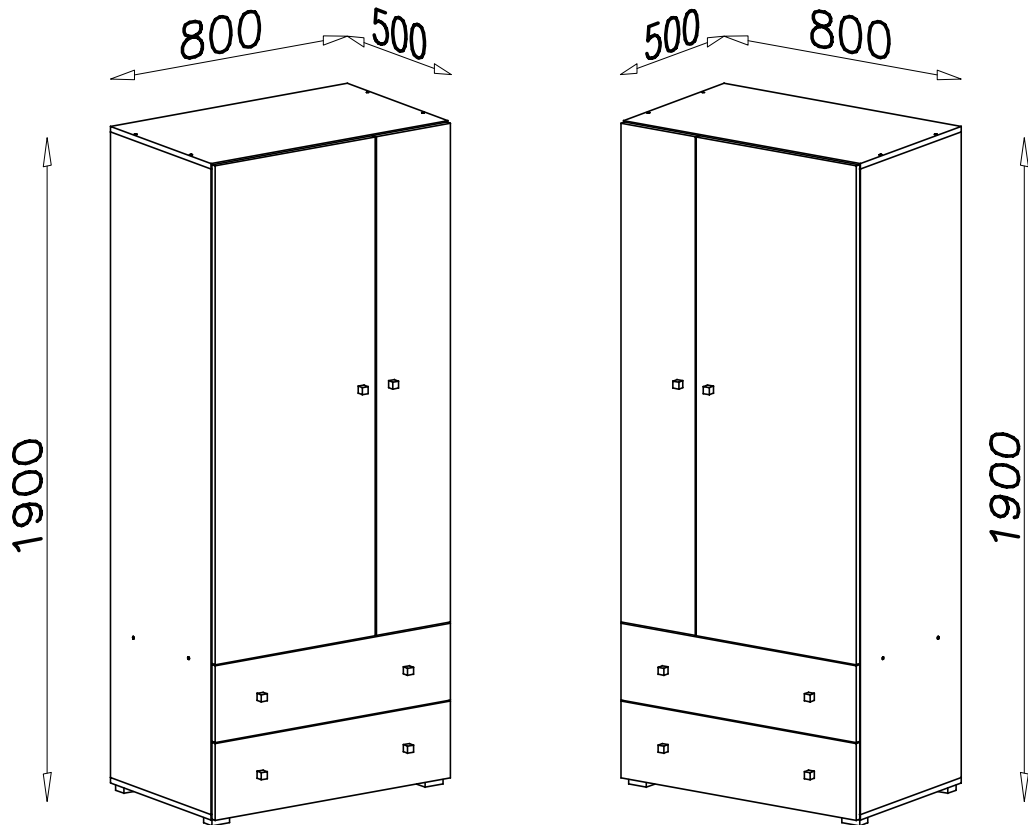

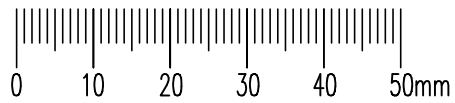

SIGMA SI 3 L/P

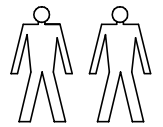
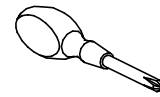
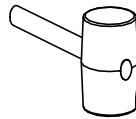
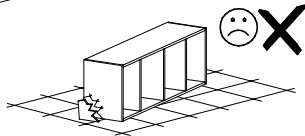
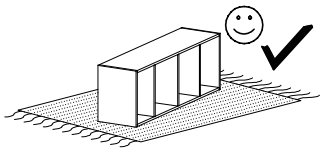
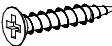

G12

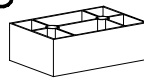
 3,5x25 x8

S3

 1406mm x1

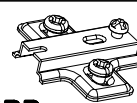
P15

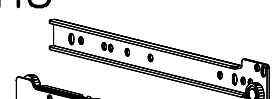
 x4

E38

 x6

D3

 PZ35PR x6

H8

 400mm x2

S1

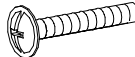
 422mm x1

W1

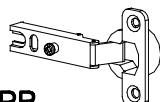
 GLUE, LEIM, LEPIDLO, LIM
 x2

N13

 M4x22 x6

C3

 Z35PR x6

400mm x2

S5

 758mm x1

G4

 4x16 x24

G2

 3x20 x60

G6

 3x13 x2

G10

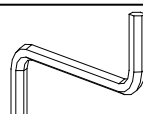
 6x13 x8

A1

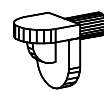
 ø7x50 x12

B7

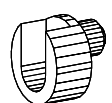
 ø8x30 x34

W2

 x1

F1

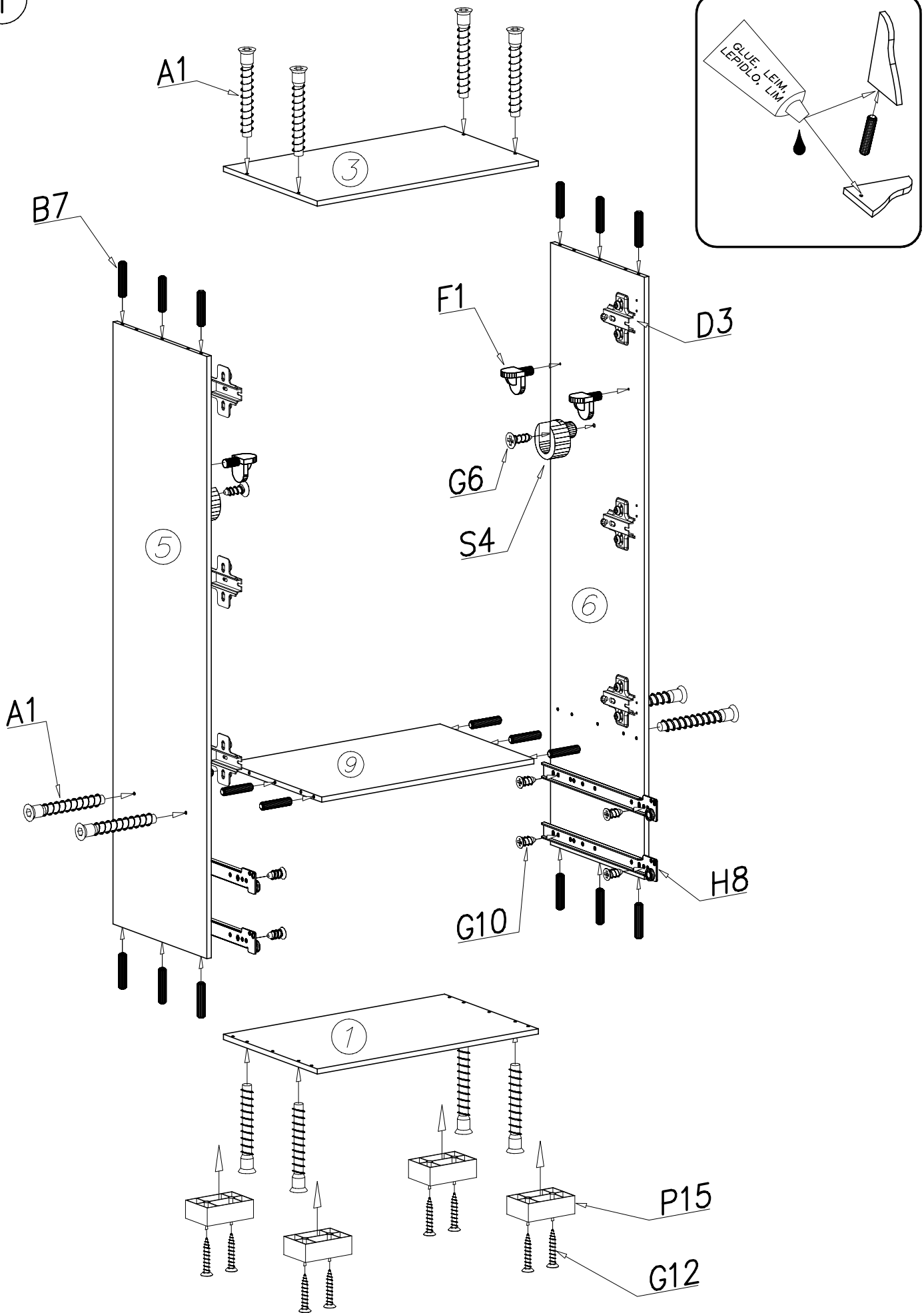
 x4

S4

 x2

I

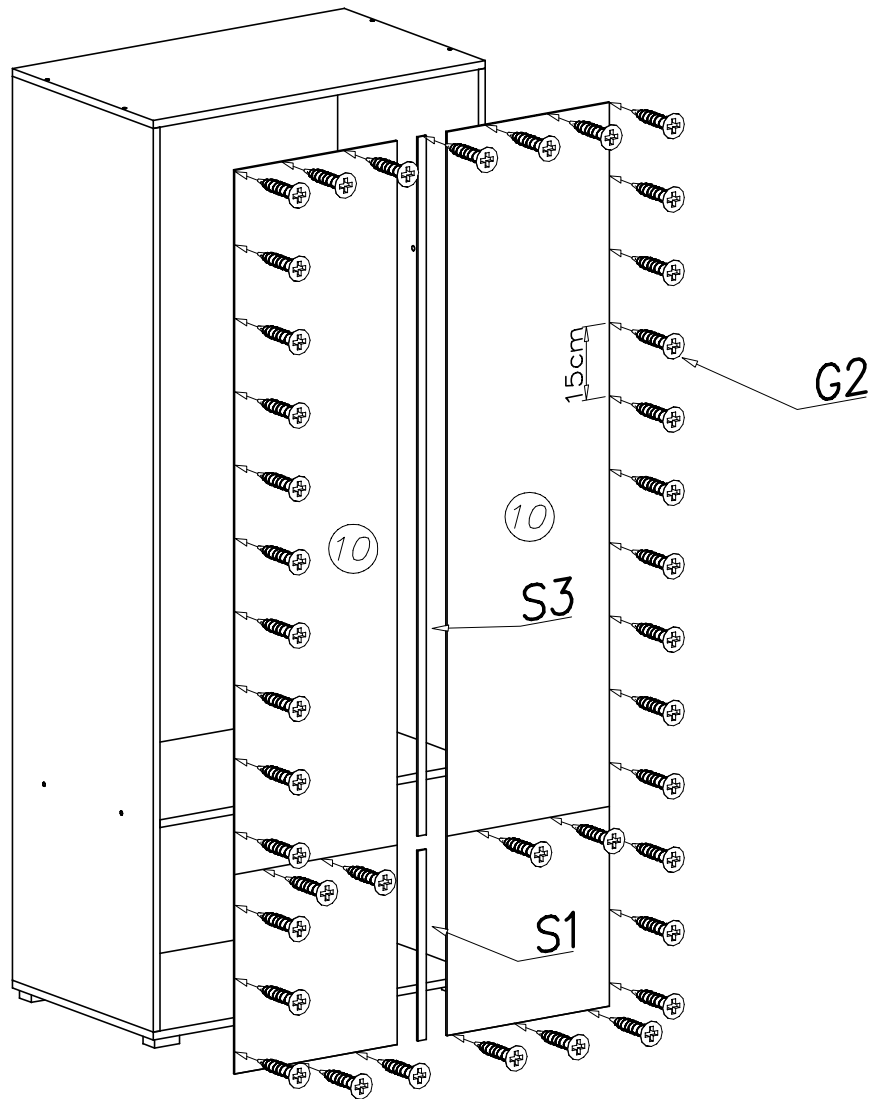

II



III

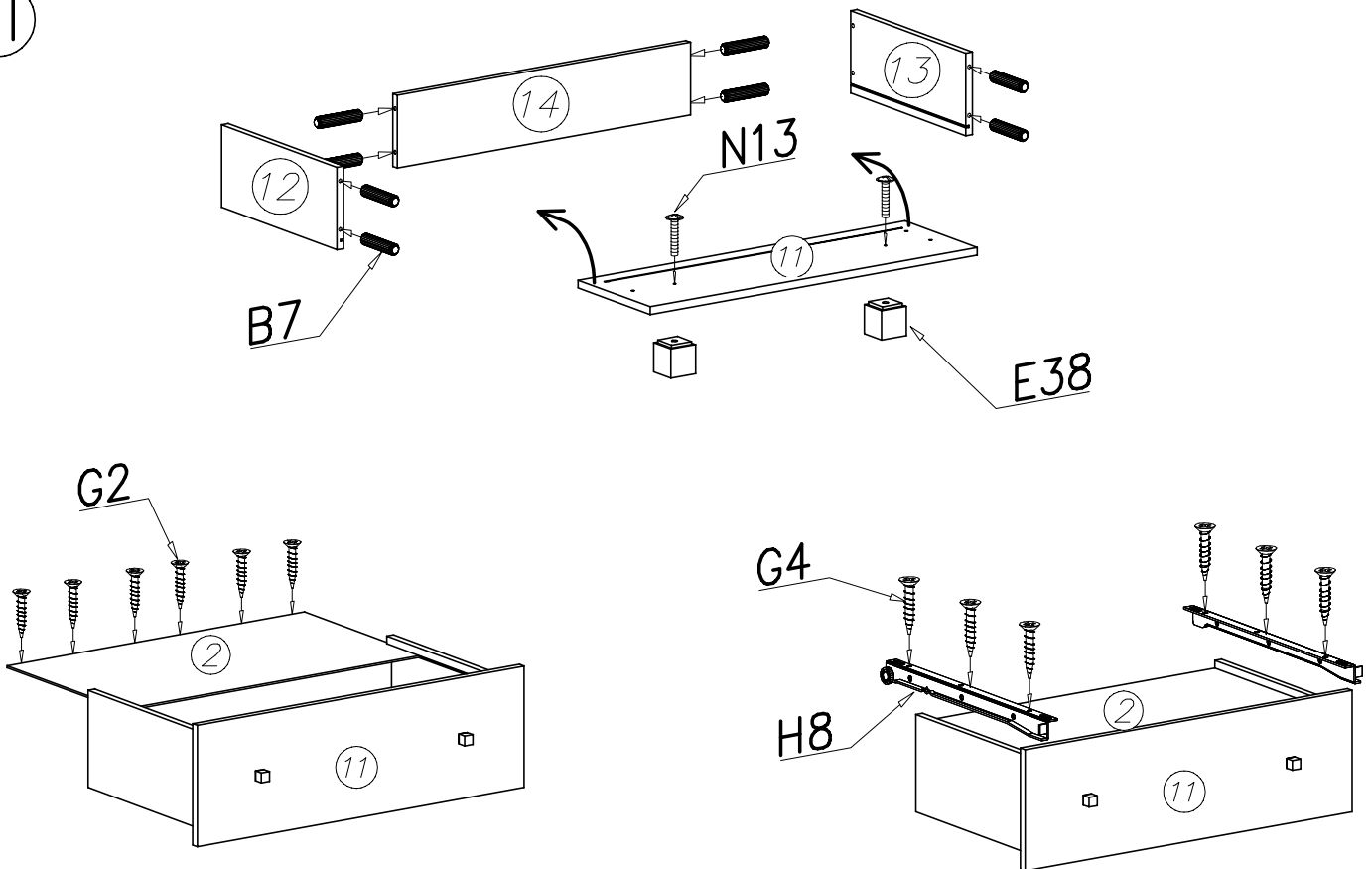

IV

