

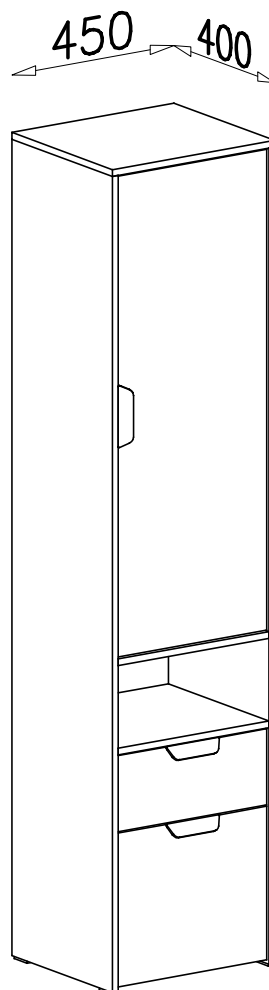

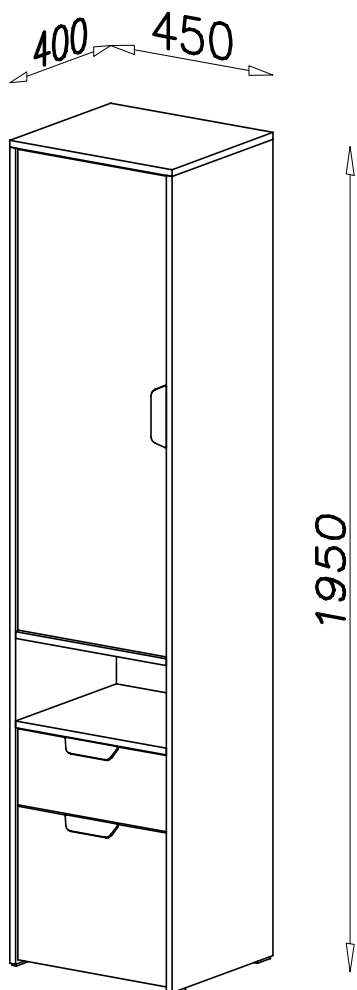

NANO

3

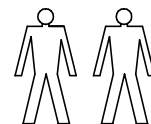
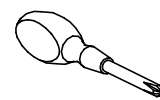
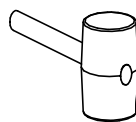
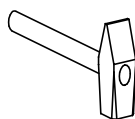
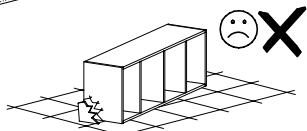
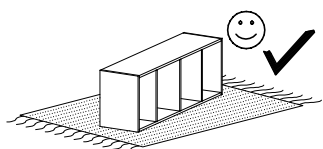

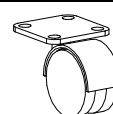
G7  3x16 x3

P7  x4

E36  x3

W1  x2
GLUE, LEIM, LEPIDLO, LIM

G13  4x22 x6

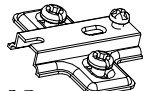
D4  x2
PZ350D

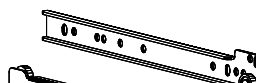
H7  350mm x1

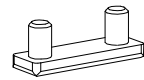
P3  x4

G4  4x16 x26

G2  3x20 x40

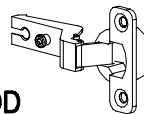
C4  x2
Z350D

A1  x13
ø7x50

B7  x41
ø8x30

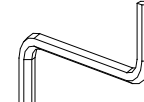
W2  x1

F1  x8

G10  6x13 x4

1

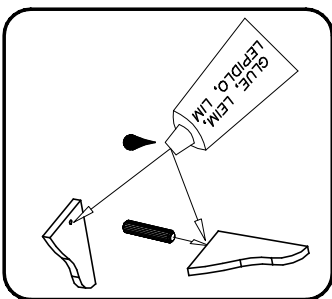
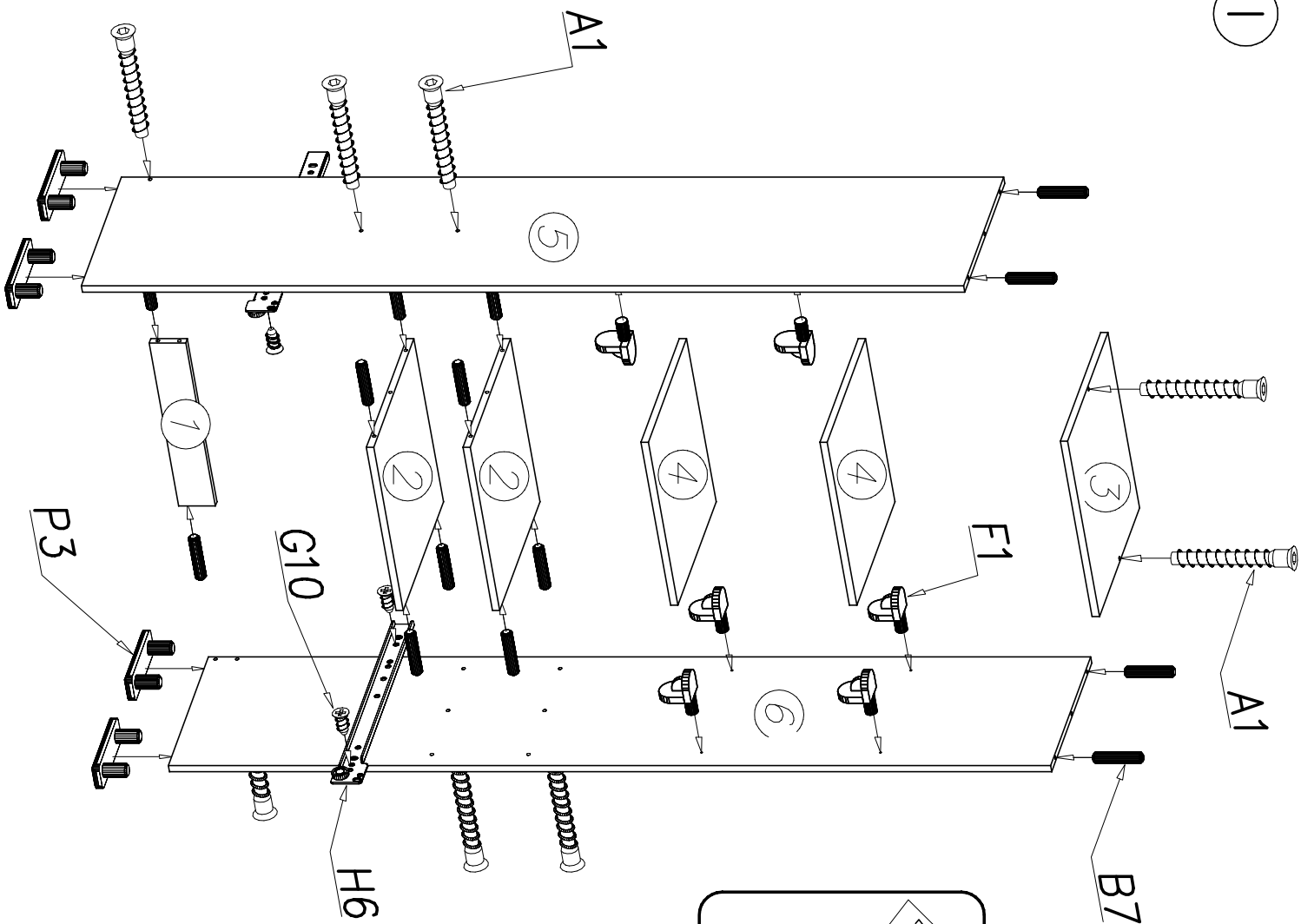

11

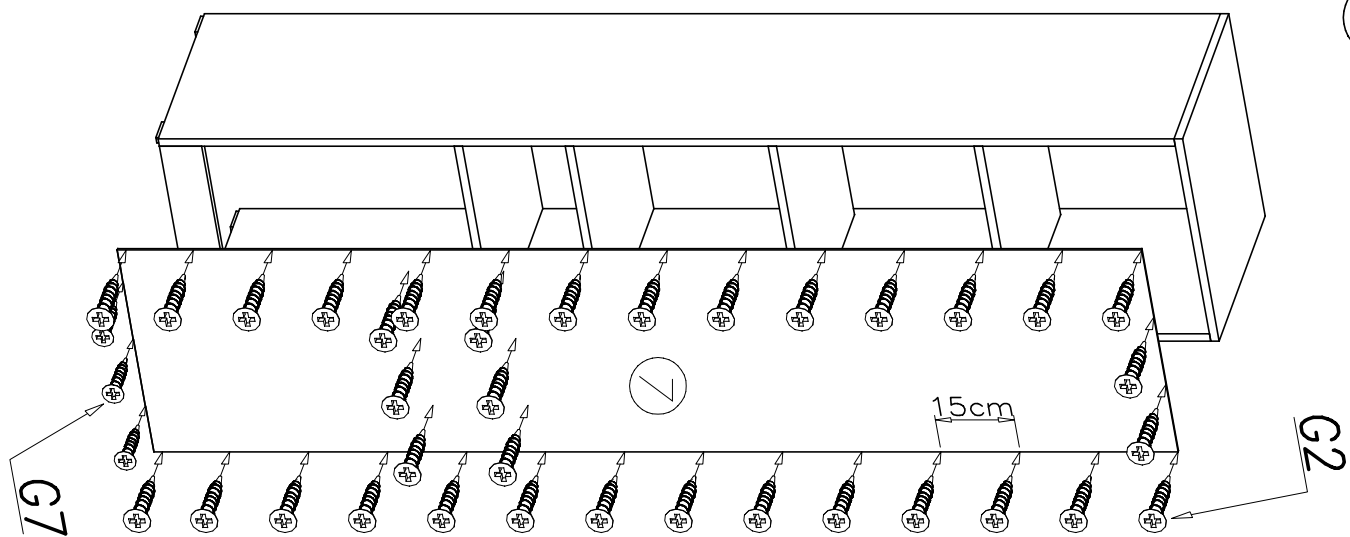

III

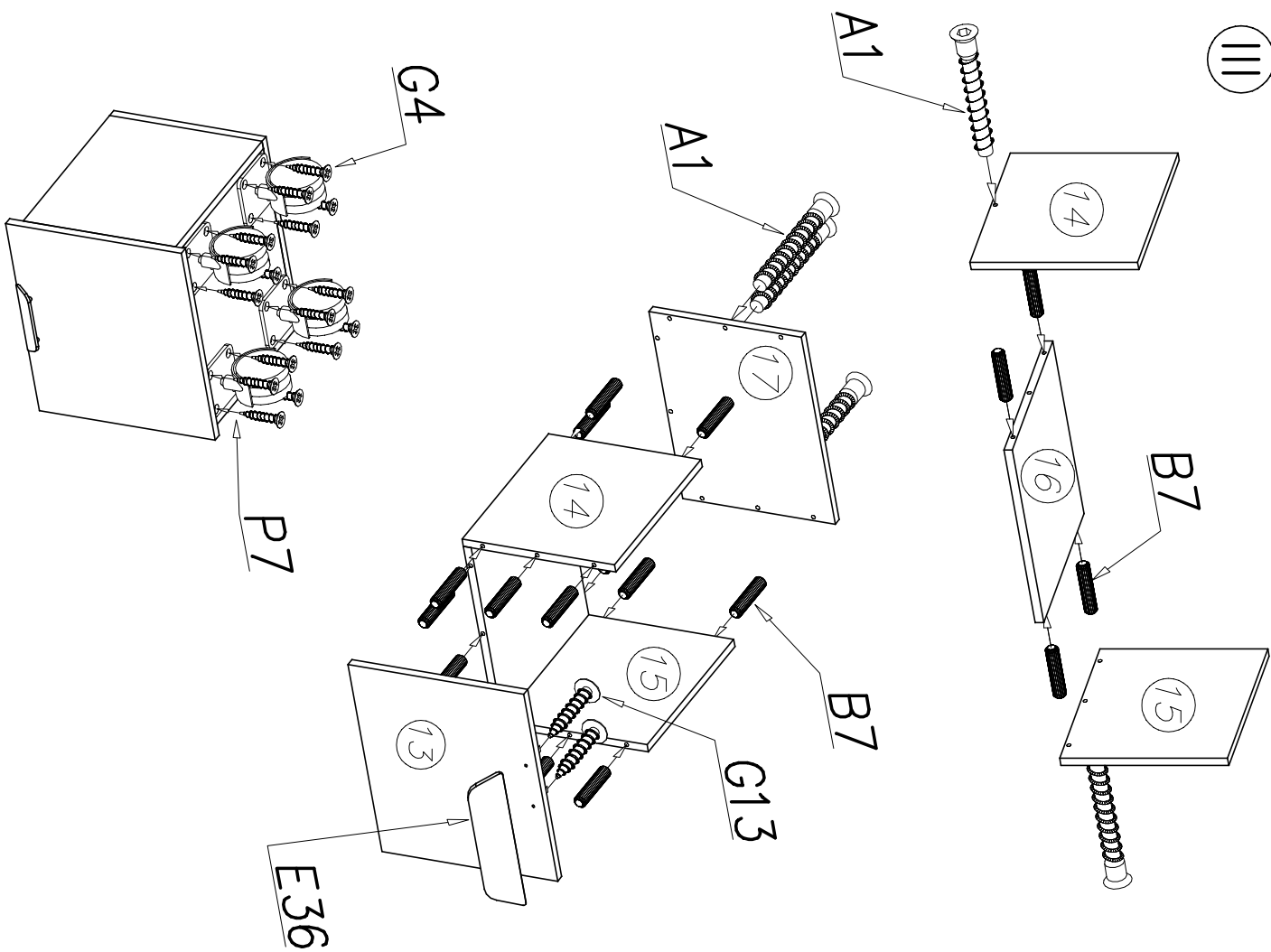

IV

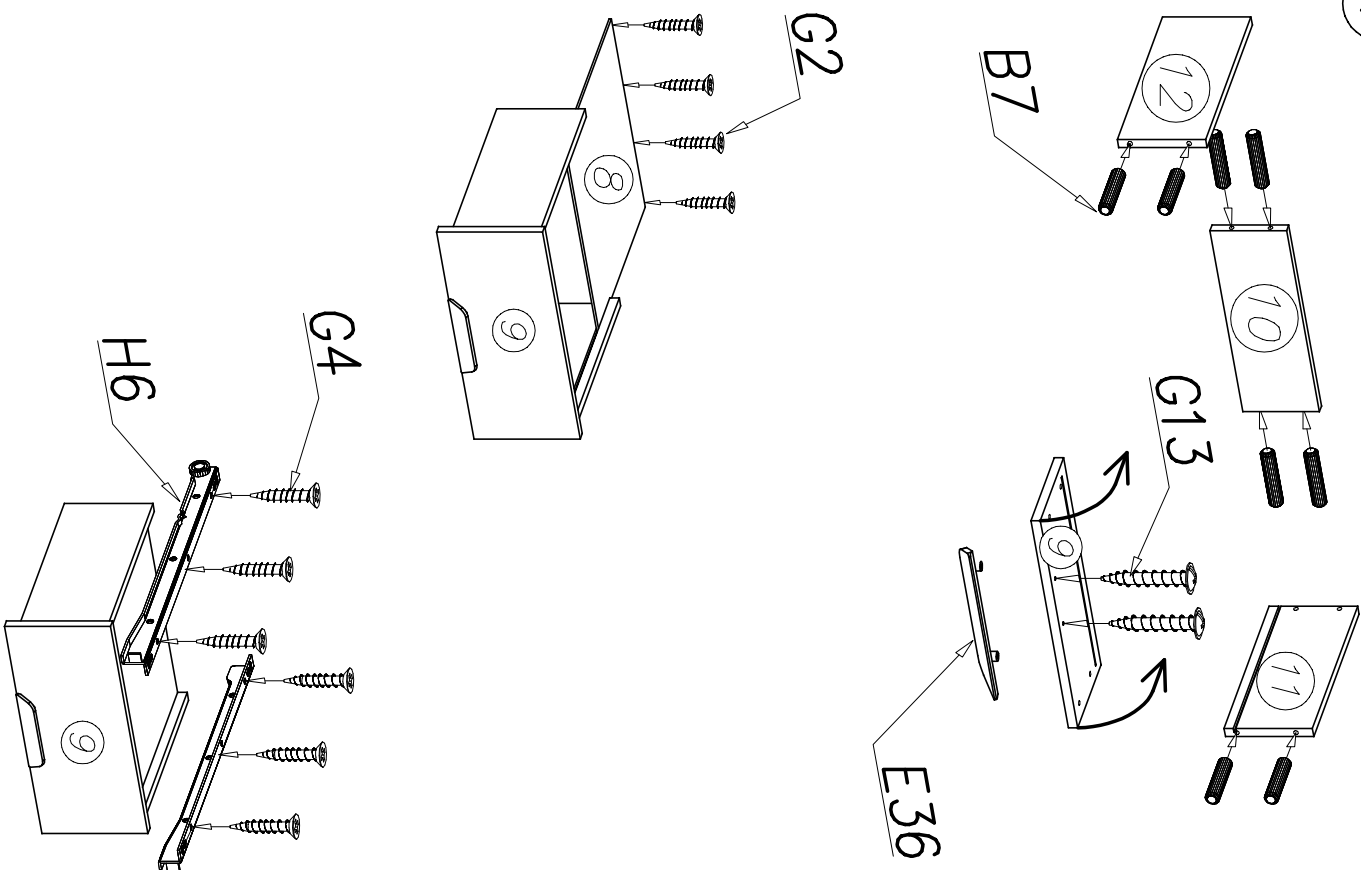

V

