

TYP 133

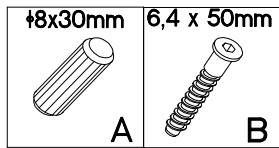

A

16

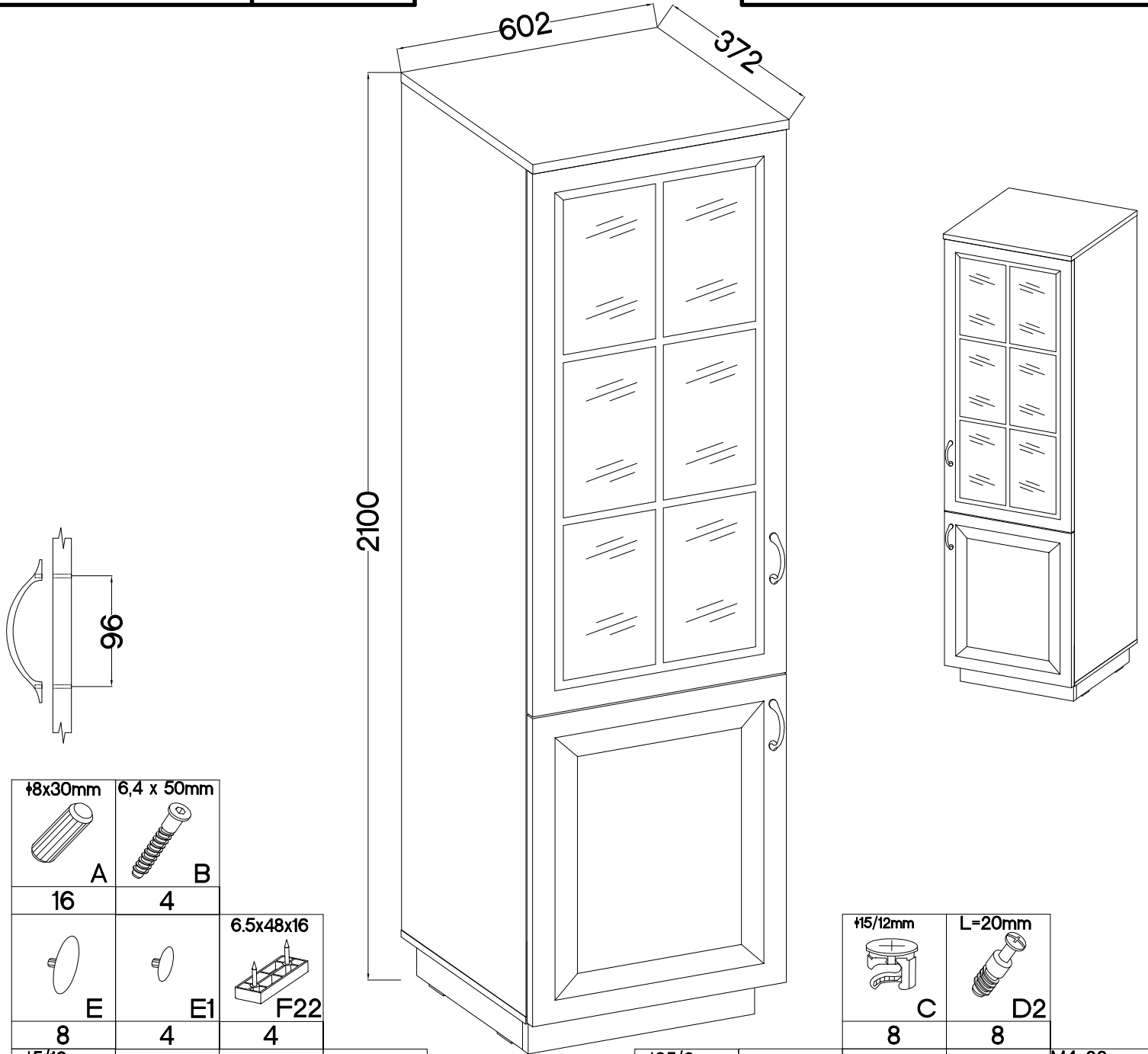
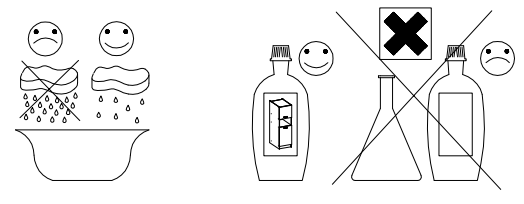
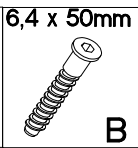

B

4

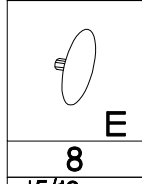

8

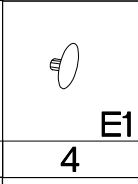

4

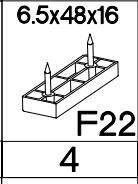

4

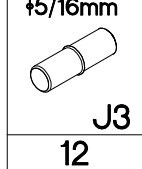

12

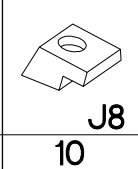

10

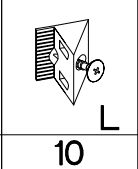

10

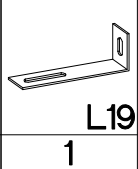

1

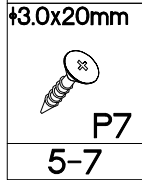

5-7

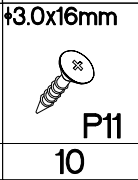

10

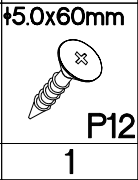

1

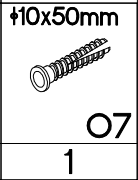

1

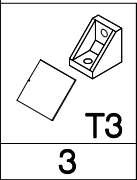

3

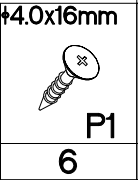

6

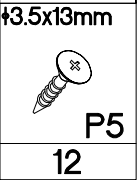

12

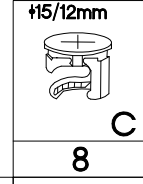

8

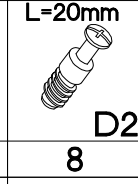

8

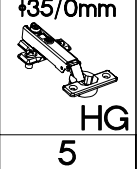

5

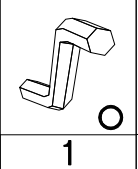

1

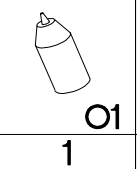

1

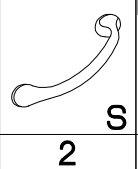

2

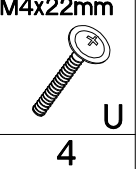

4

ISM-FLA-15

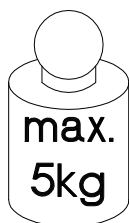
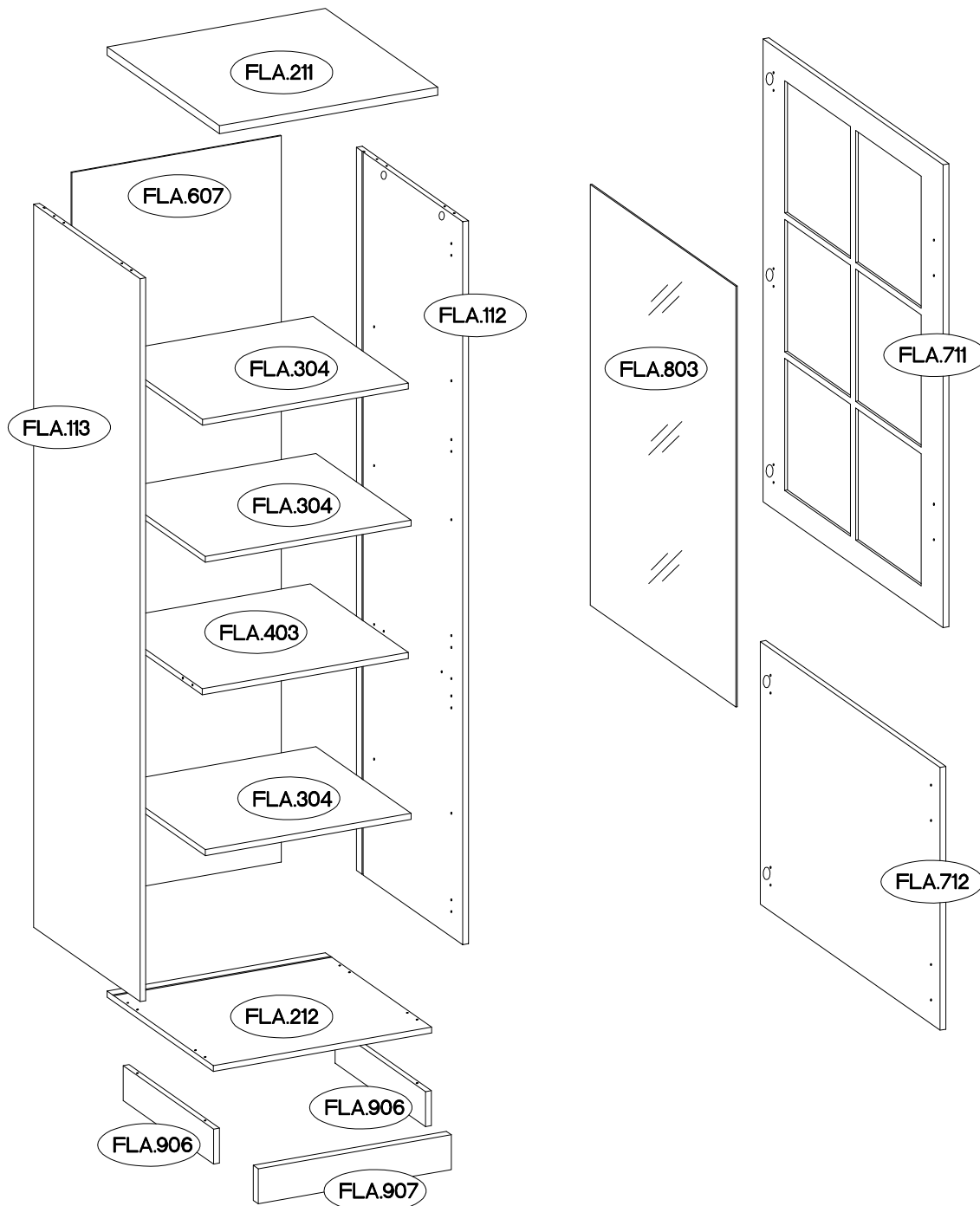



FLA.304

FLA.403

Colli	Ersatzteil Nummer	Dimension
Colli 1/2	FLA.211	602x372x22
	FLA.212	602x352x16
	FLA.304 x3	567x315x16
	FLA.403	568x324x16
	FLA.906 x2	300x95x16
	FLA.907	532x95x16

Colli	Ersatzteil Nummer	Dimension
Colli 2/2	FLA.112	1962x352x16
	FLA.113	1962x352x16
	FLA.607	1971x577x2.5
	FLA.711	1256x596x16
	FLA.712	713x596x16
	FLA.803	1142x482x4

1

$\pm 8 \times 30 \text{mm}$  A 12	$\pm 15 / 12 \text{mm}$  C 8	L=20mm  D2 4
--	---	---

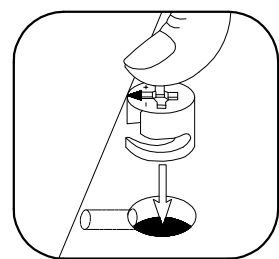
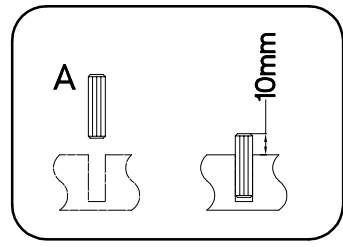
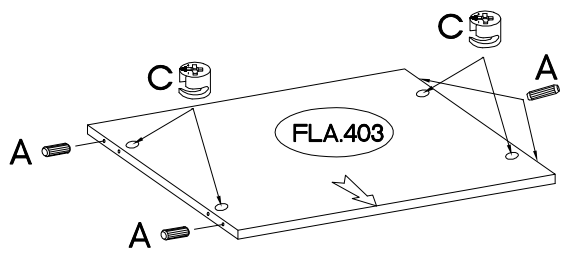
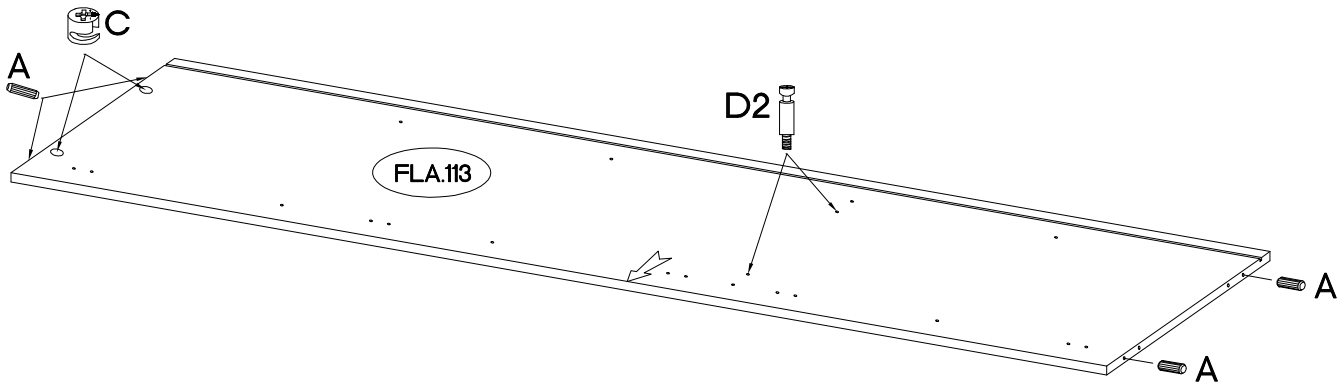
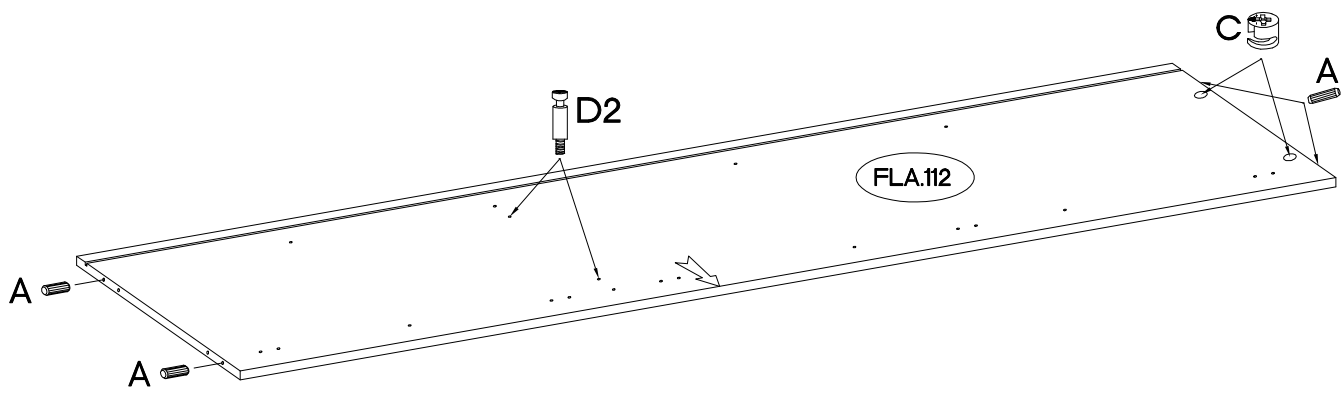
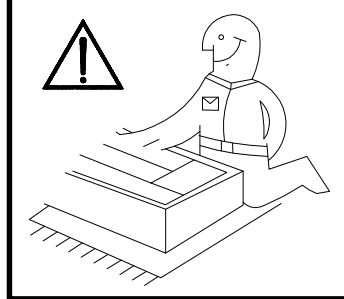
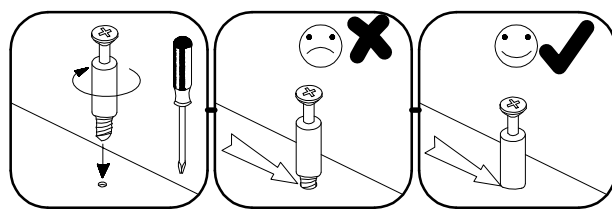

2

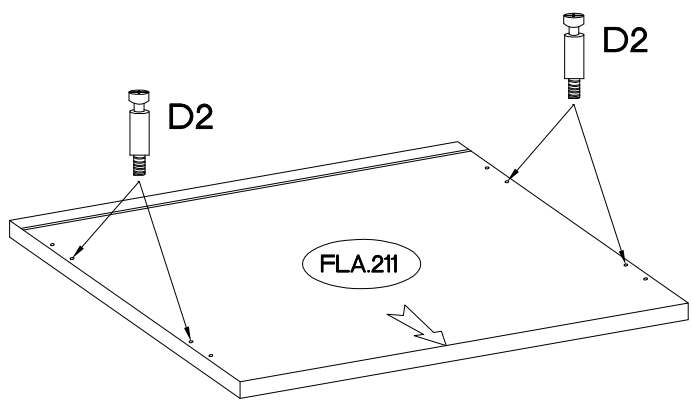
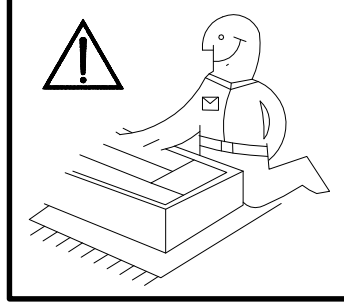
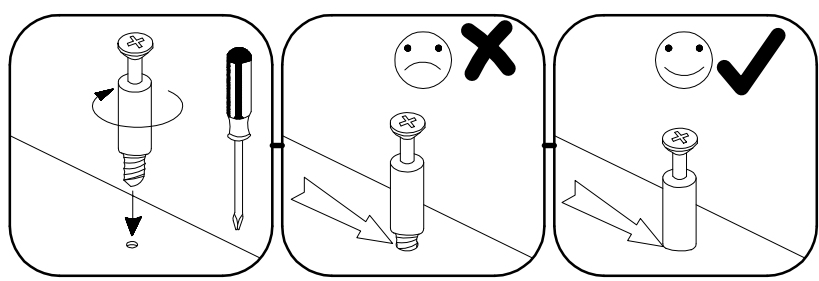
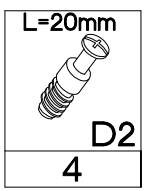

3

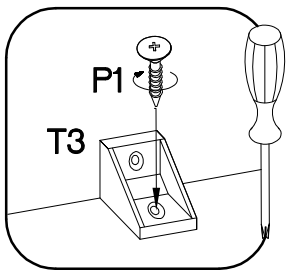
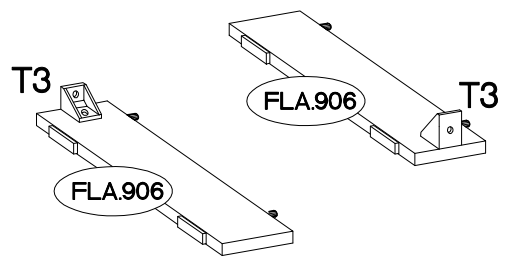
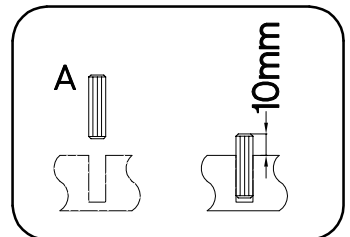
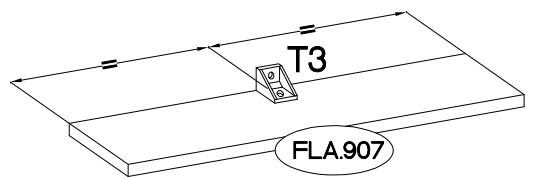
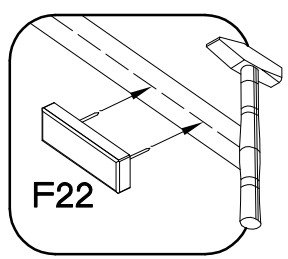
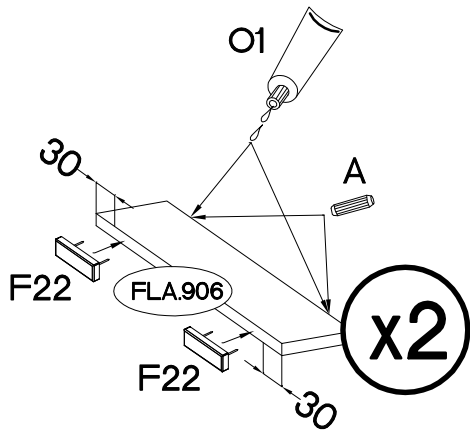
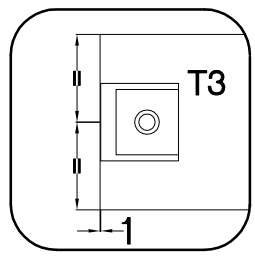

	+4.0x16mm	6.5x48x16		+8x30mm
T3	P1	F22	O1	A
3	3	4	1	4

4

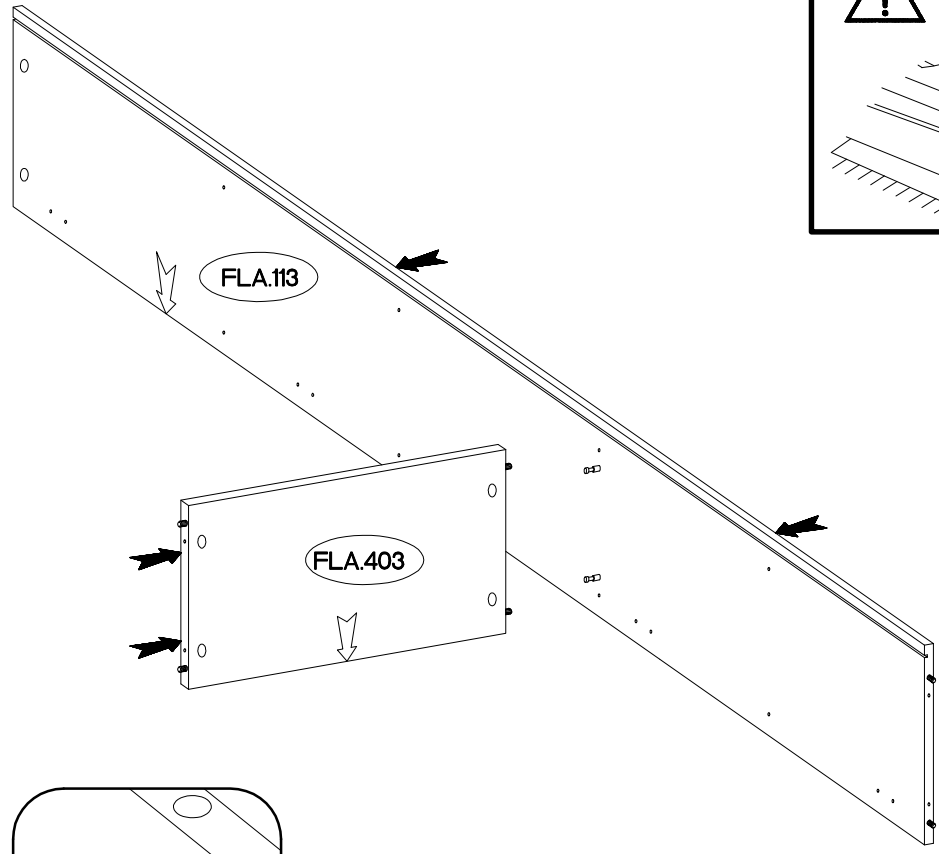
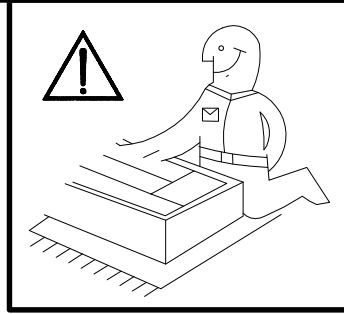

5

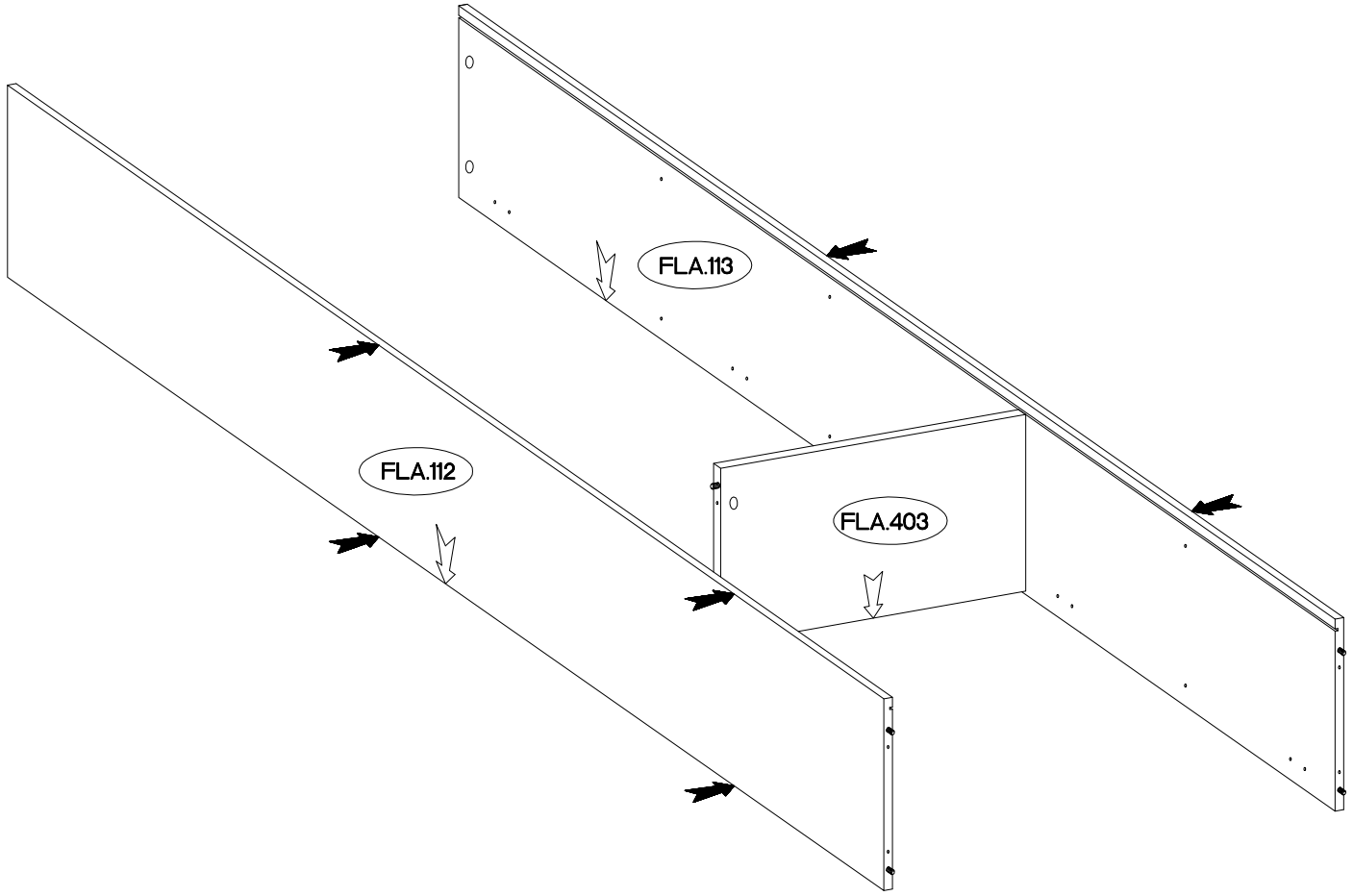
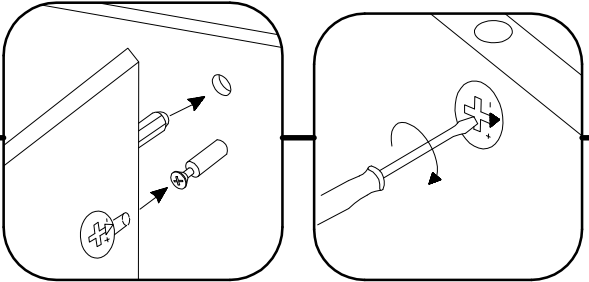

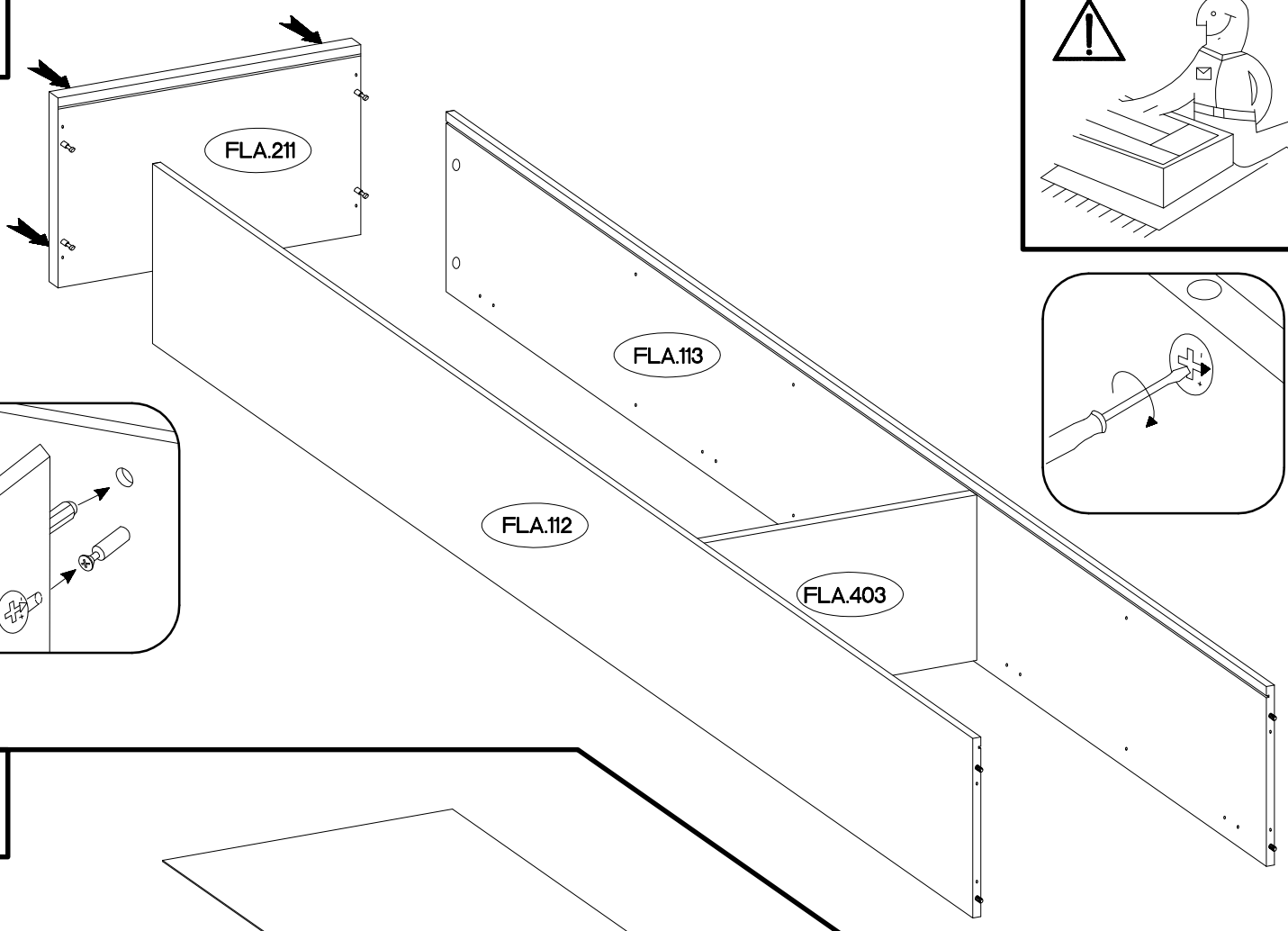

6

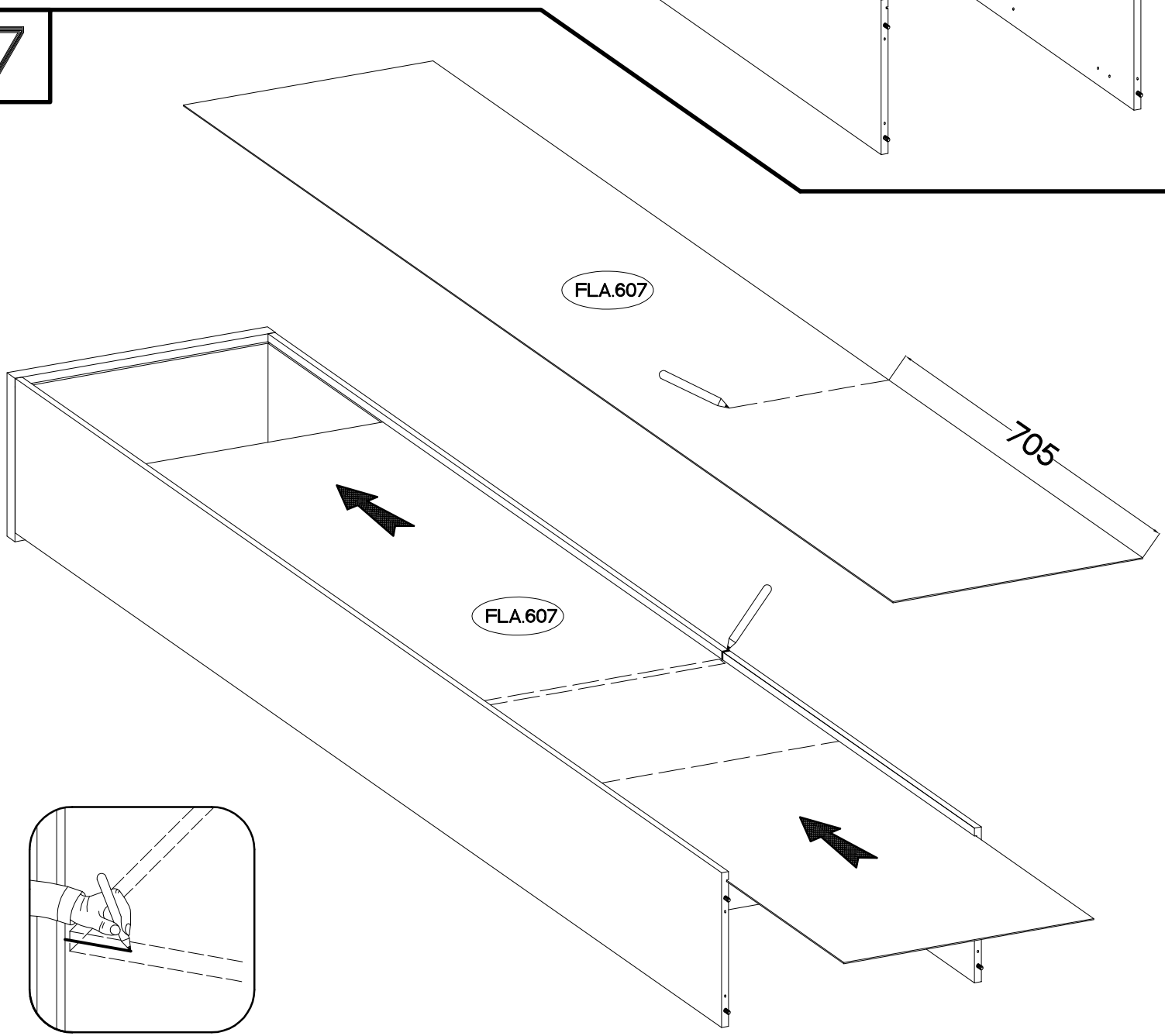

7



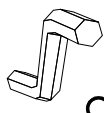

8

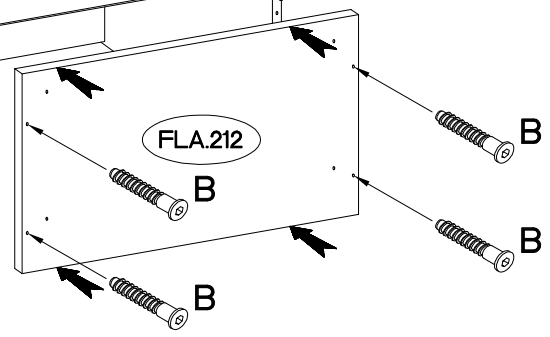
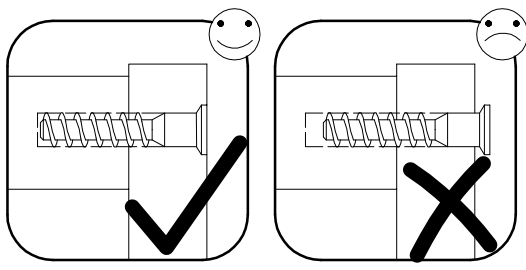
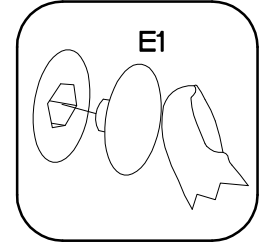
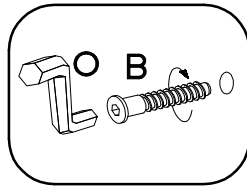
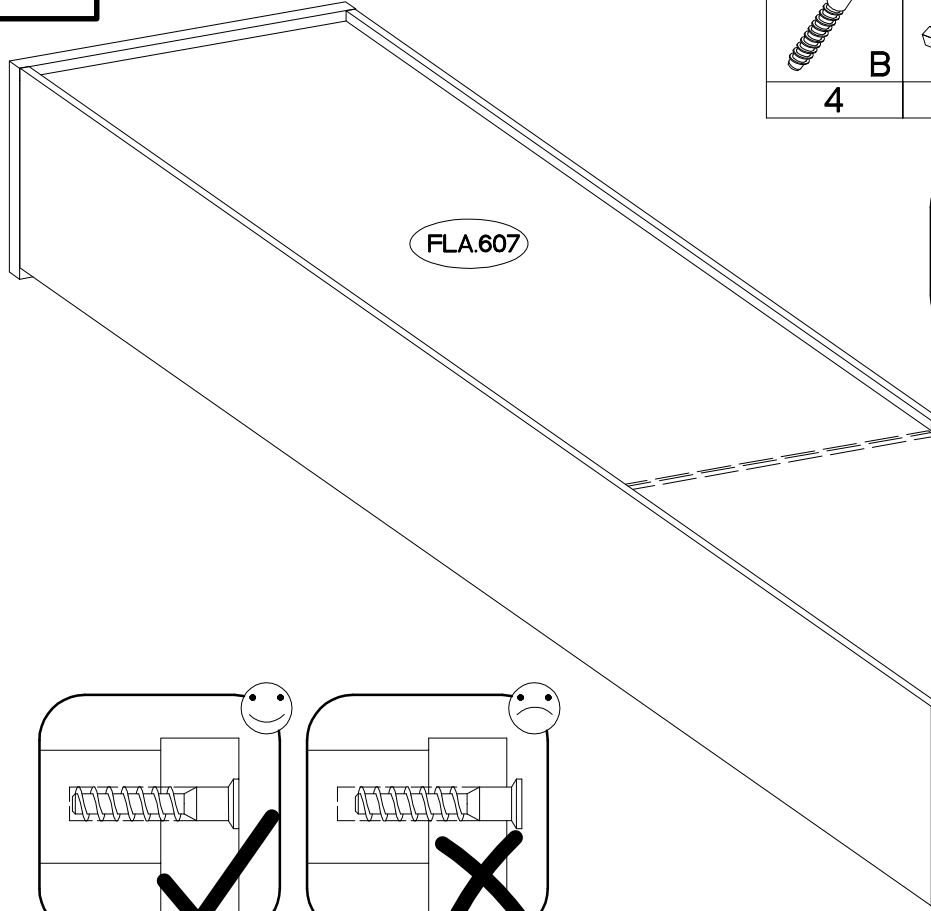
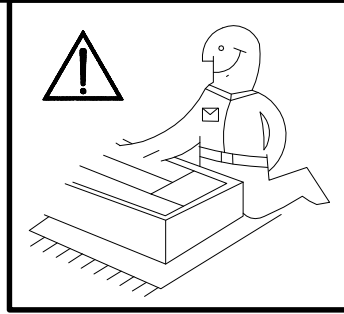
6,4 x 50mm 		
B	O	E1
4	1	4

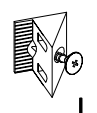

9

	+3.0x20mm 
L	P7
10	5-7

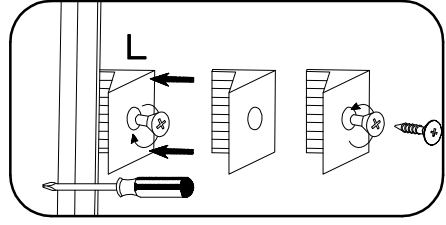
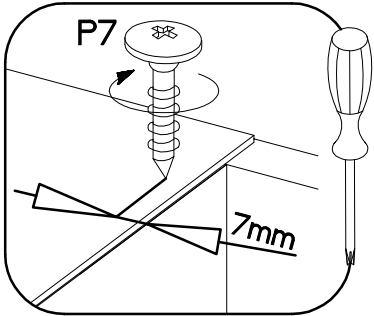
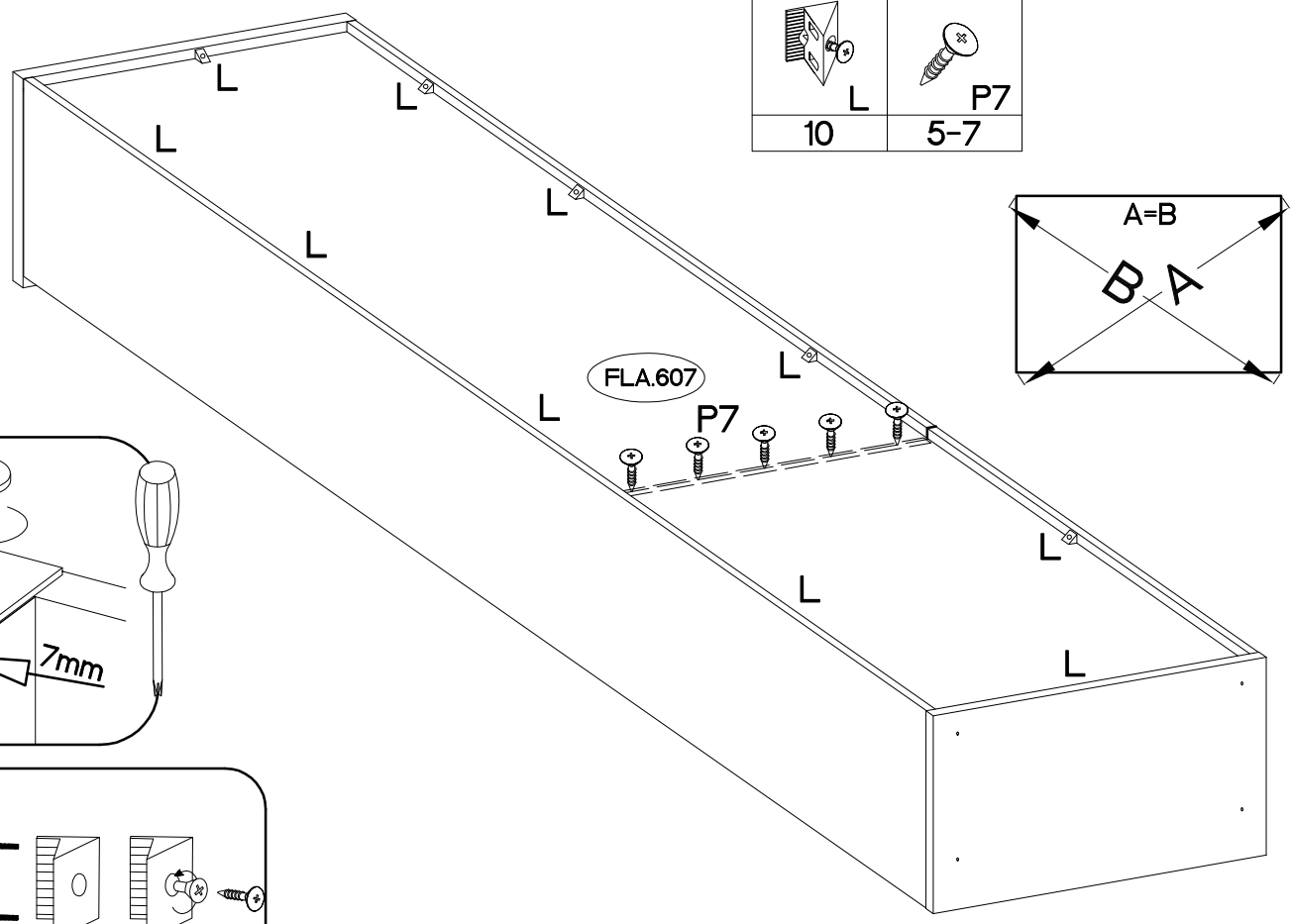

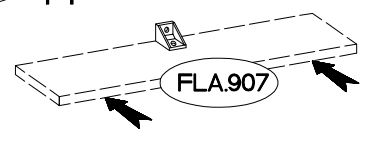
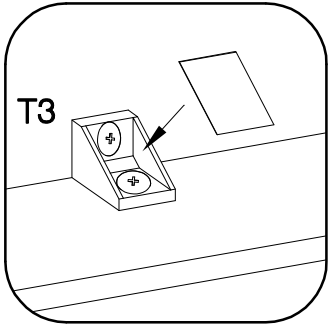
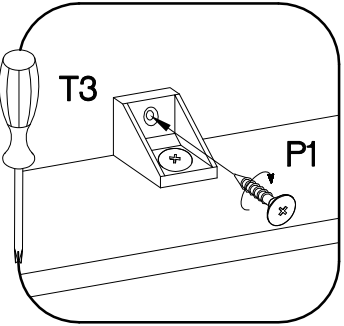
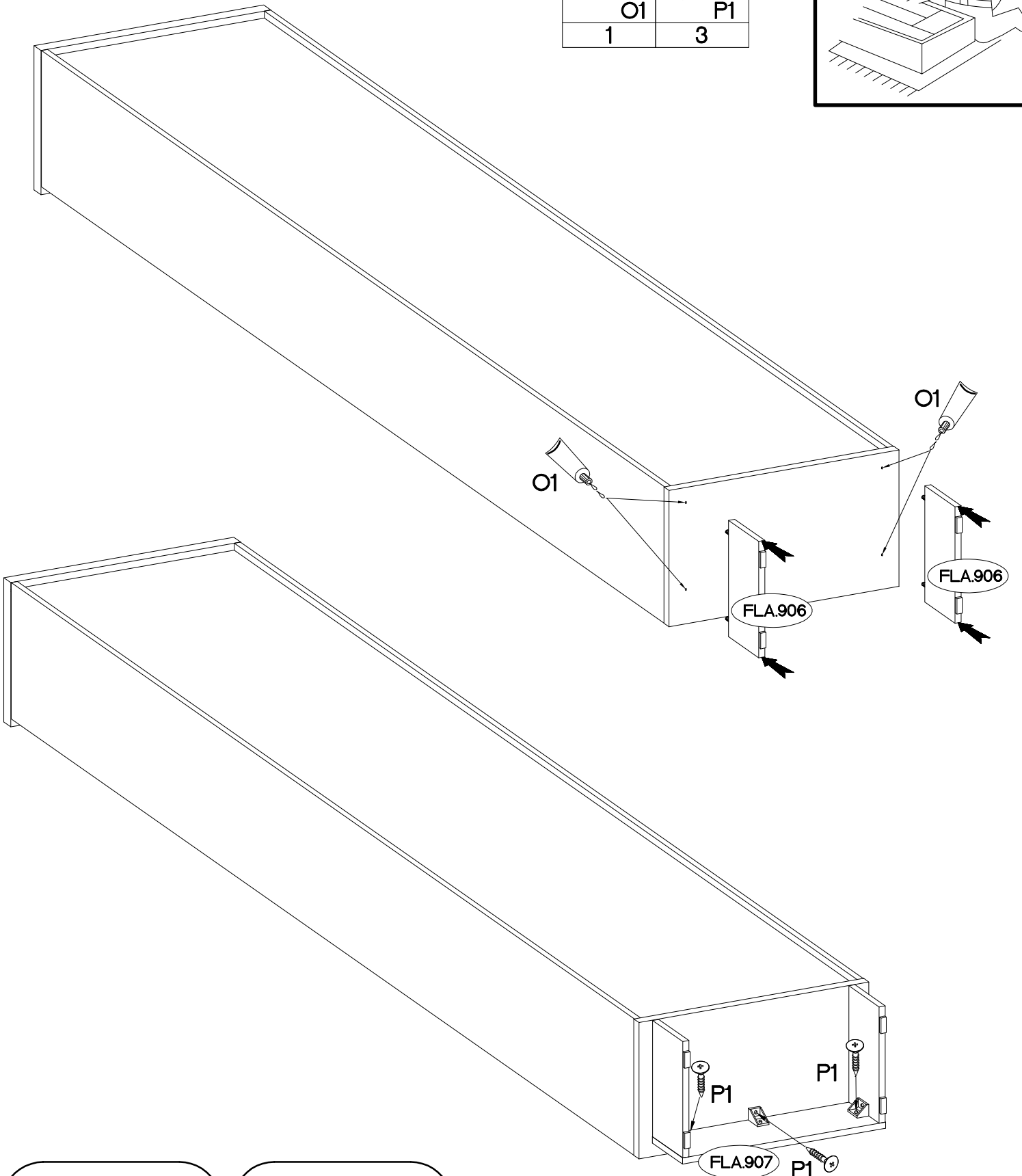
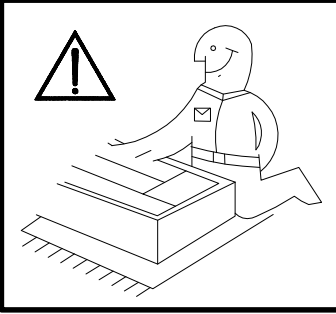

	#4.0x16mm
O1	P1
1	3

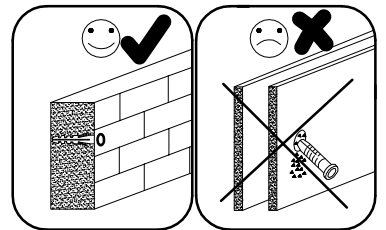
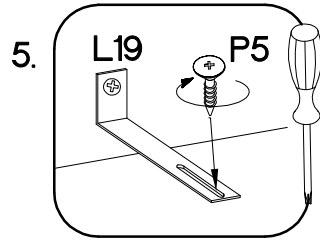
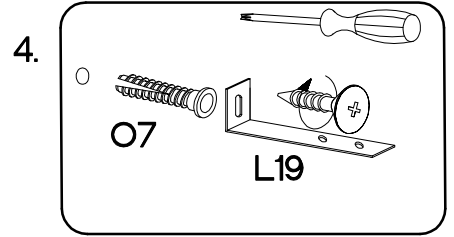
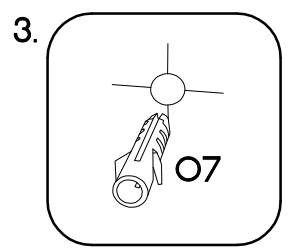
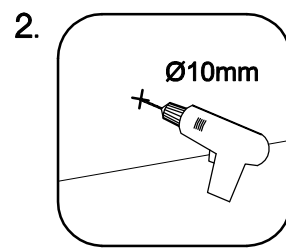
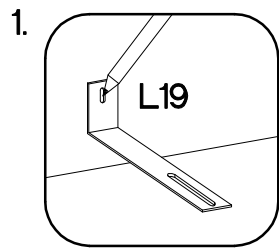
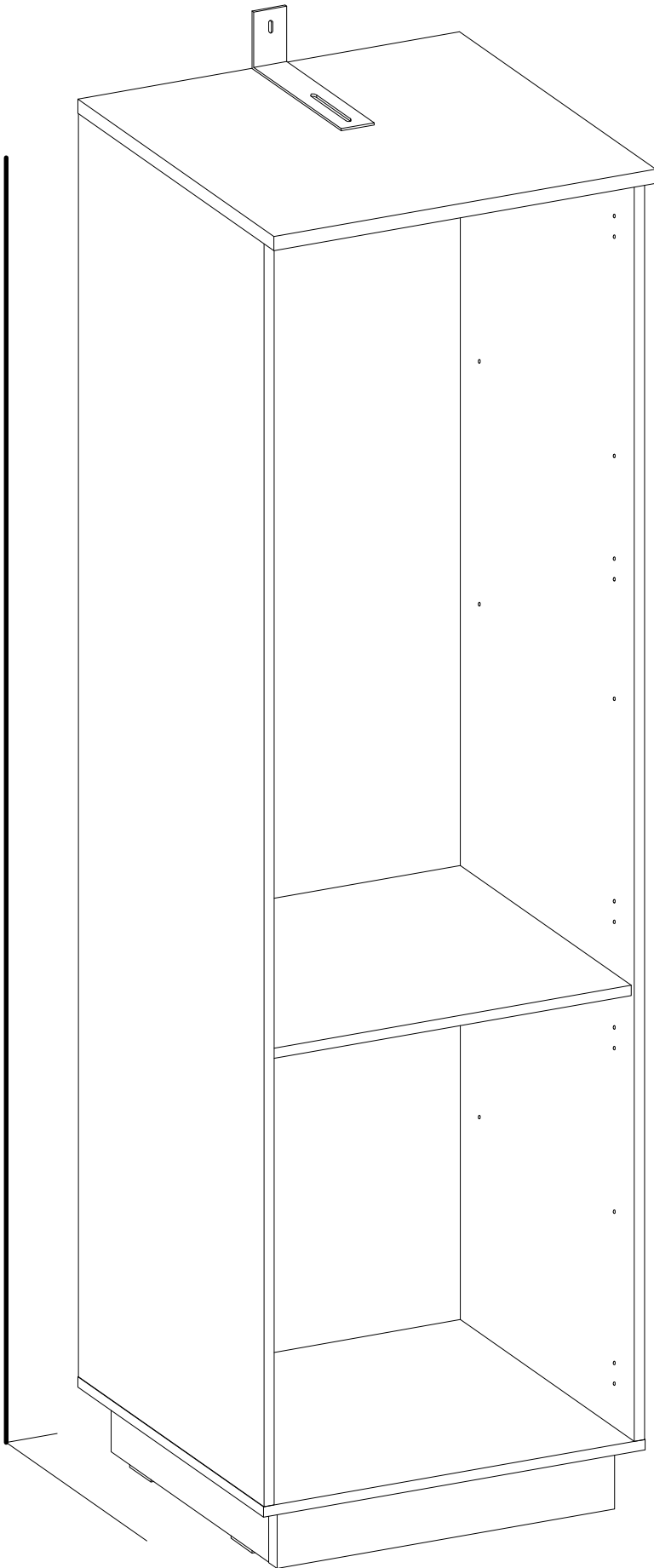





	±3.5x13mm	±5.0x60mm	±10x50mm
L19	P5	P12	O7
1	2	1	1

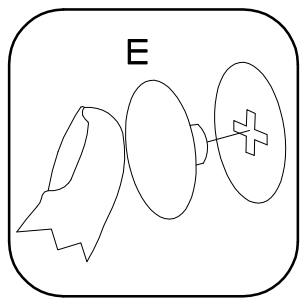
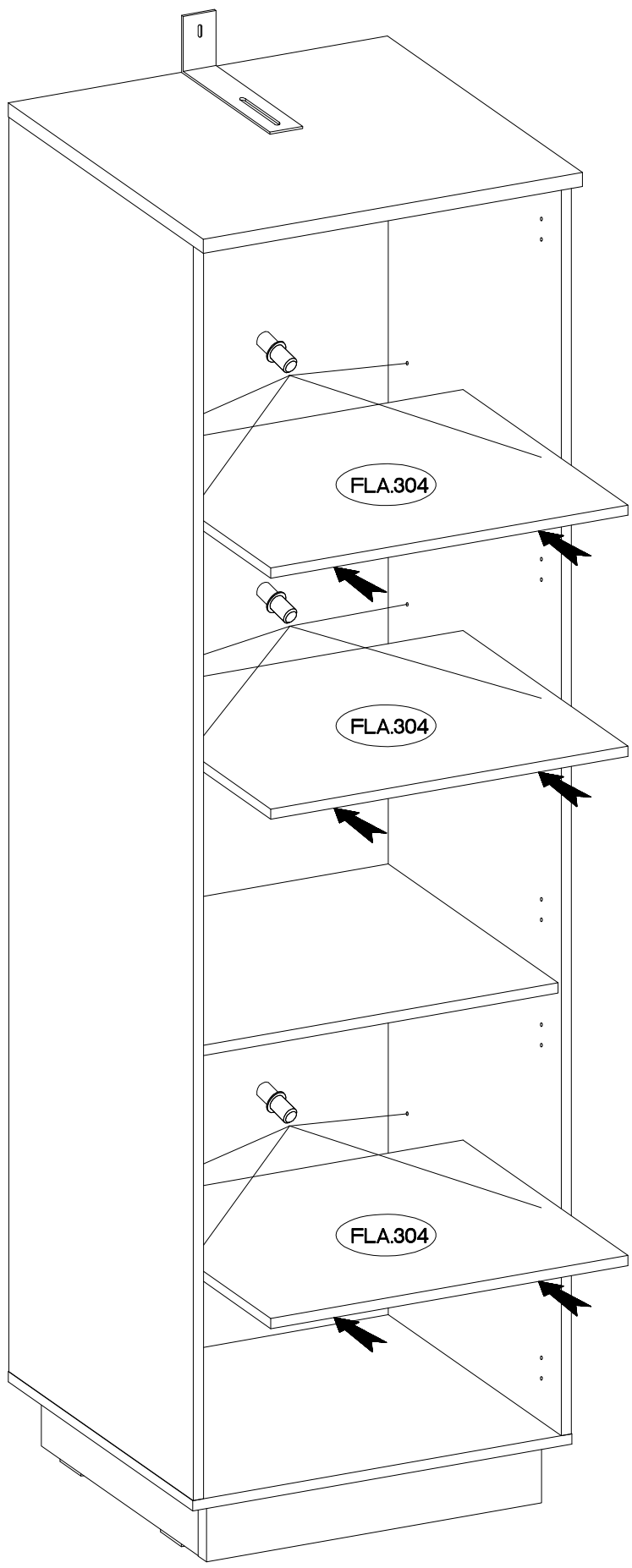
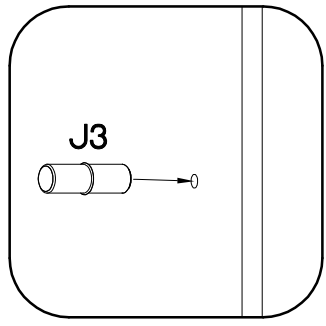

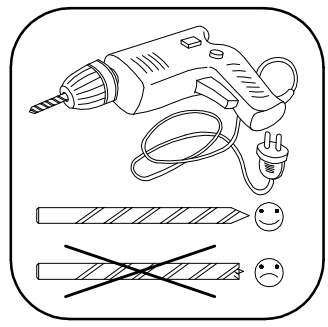
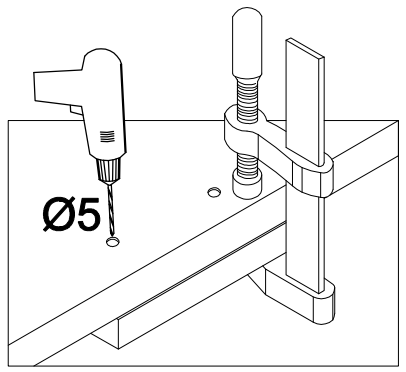
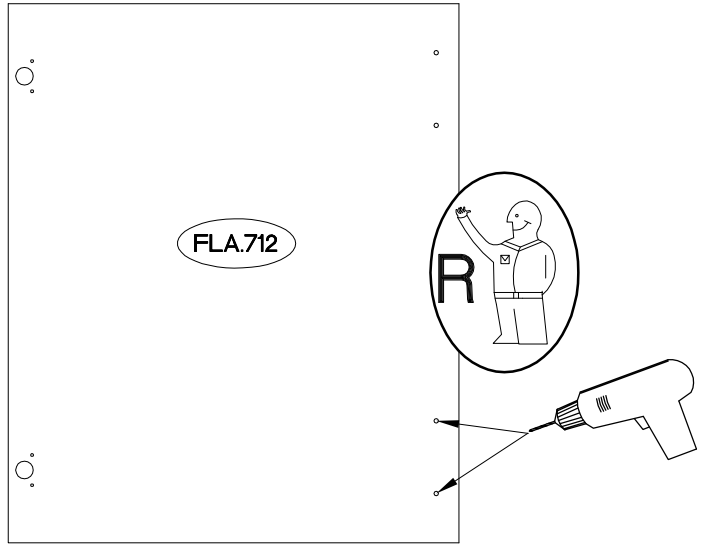
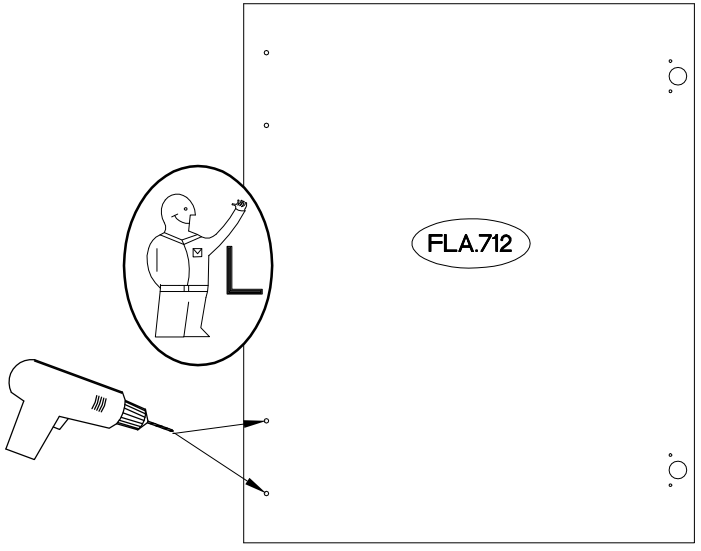
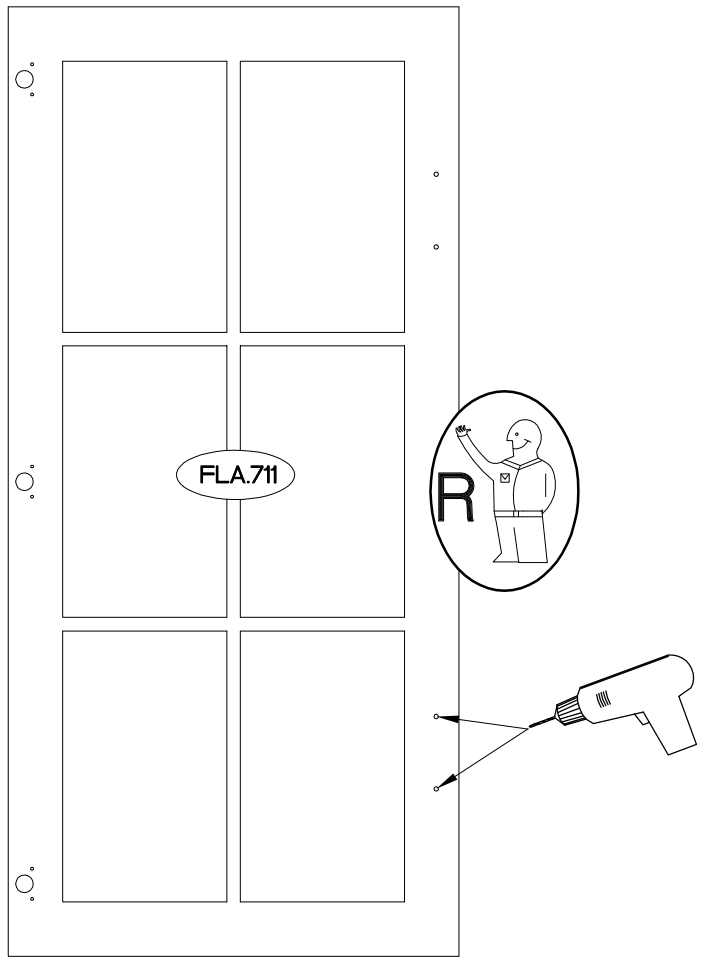
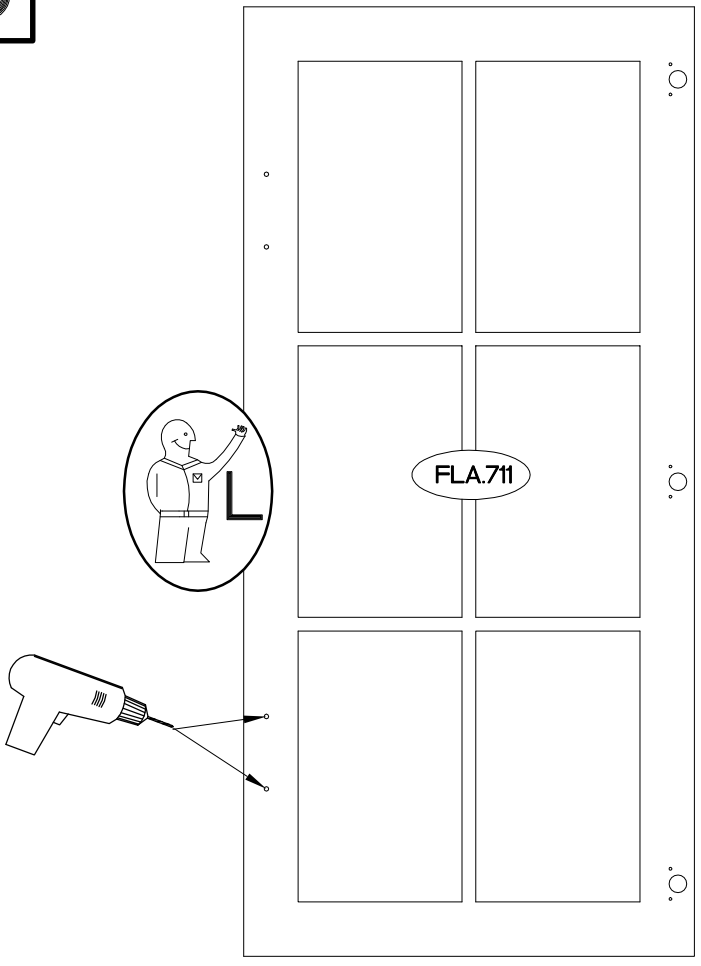
±5/16mm		
J3		E
12		8

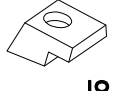



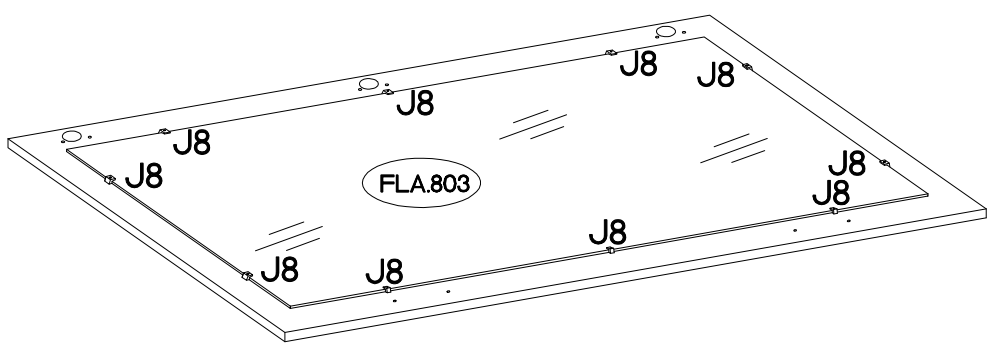
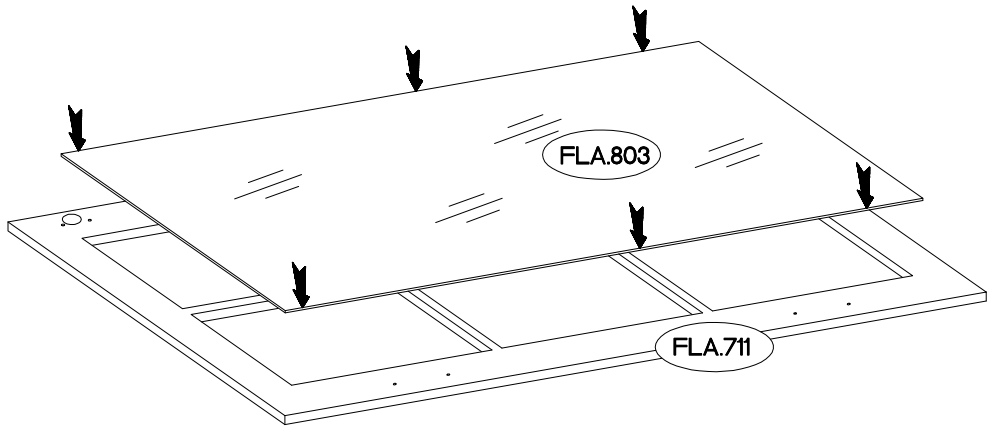
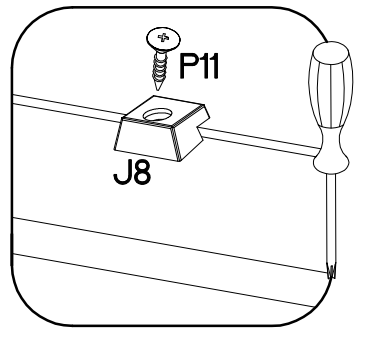
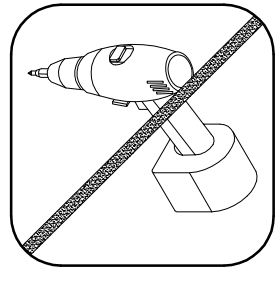
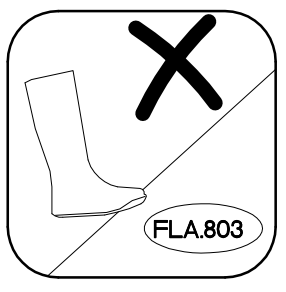
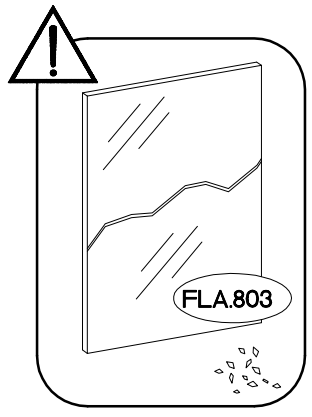
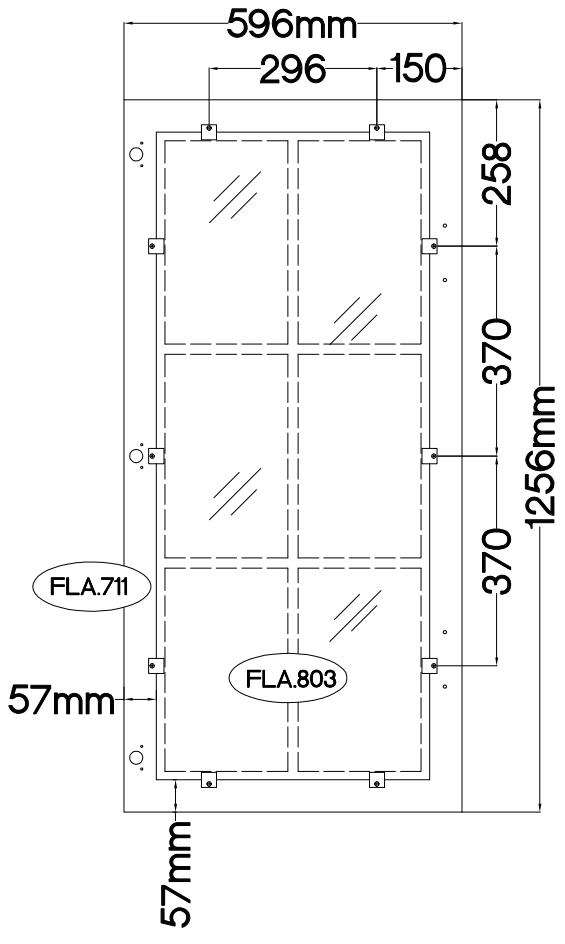
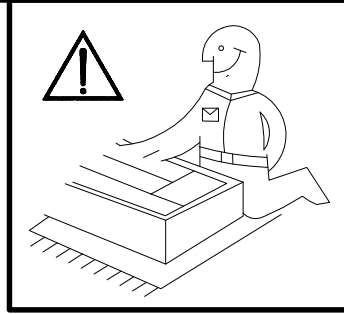

	±3.0x16mm 
J8	P11
10	10

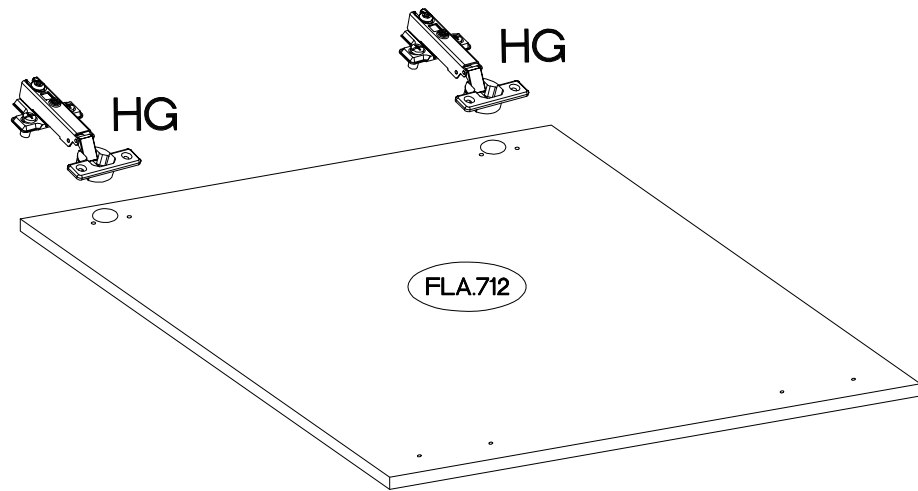
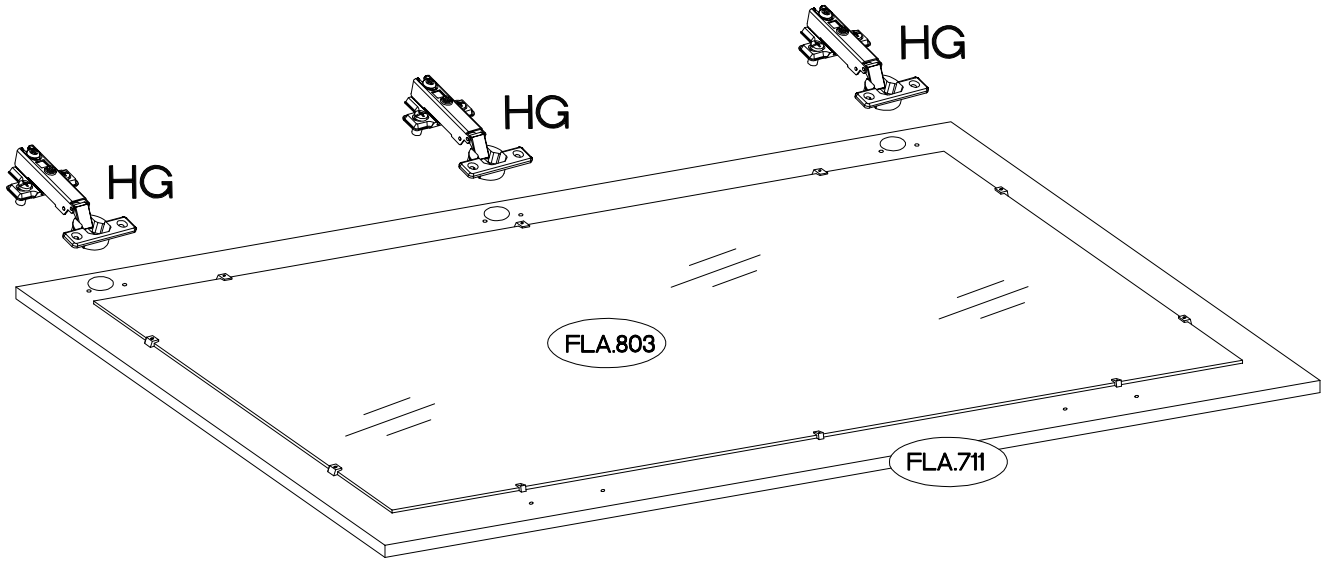
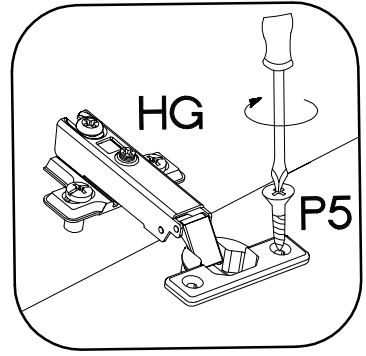

 $\pm 35/0\text{mm}$	 $\pm 3.5 \times 13\text{mm}$
HG	P5
5	10



M4x22mm	
	
U	S
4	2

