

30 min

MALTA

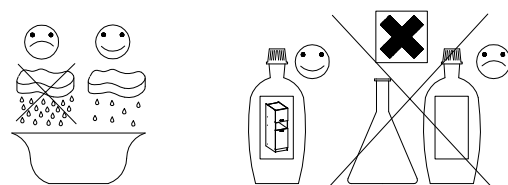

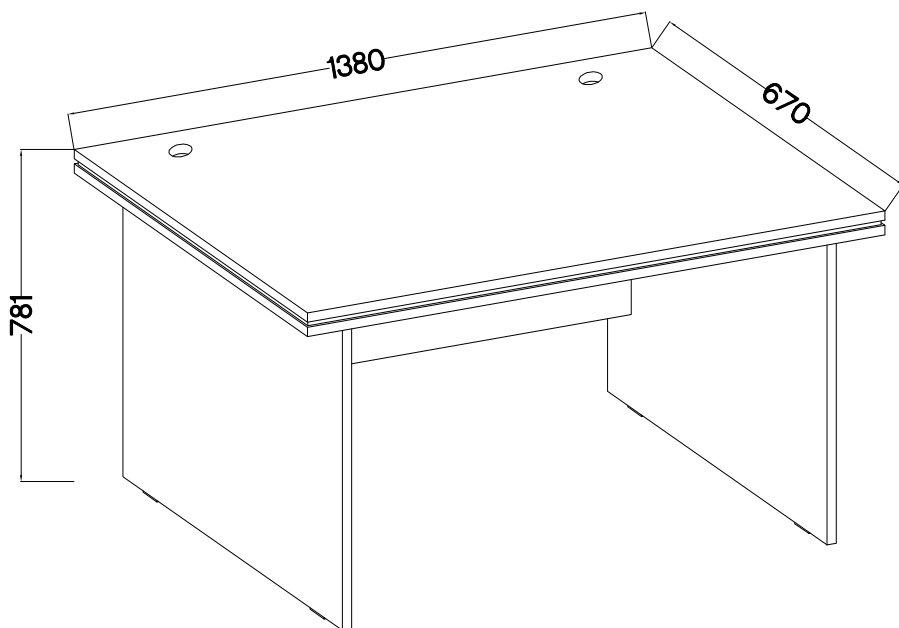



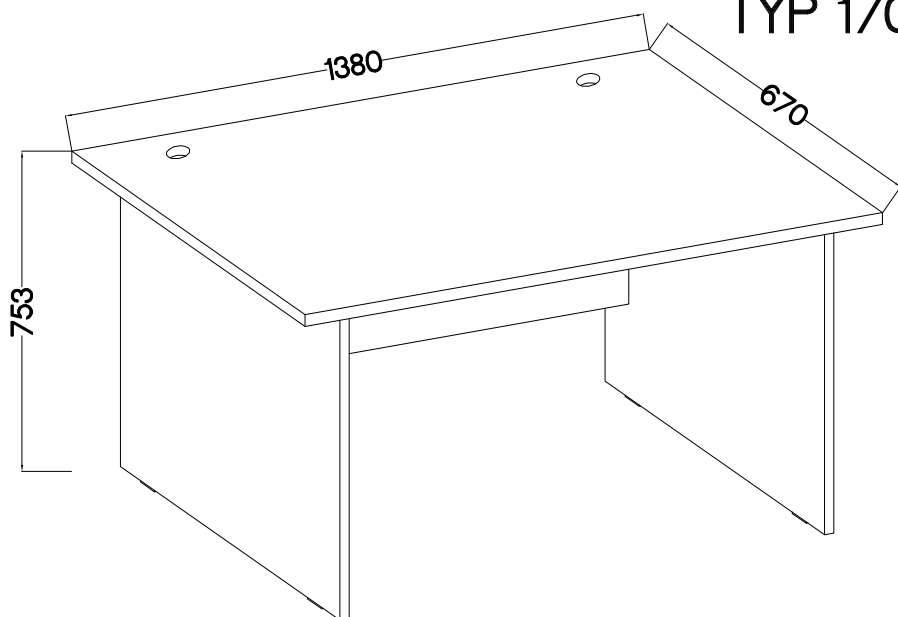

TYP 180



TYP 170



±8x30mm 	±15/12mm 	L=20mm 	6.5x48x16 	±60 	±20 
A	C	D2	F2	E8	E11
4	12	12	4	2	12

ISM-MTA-20

TYP 180

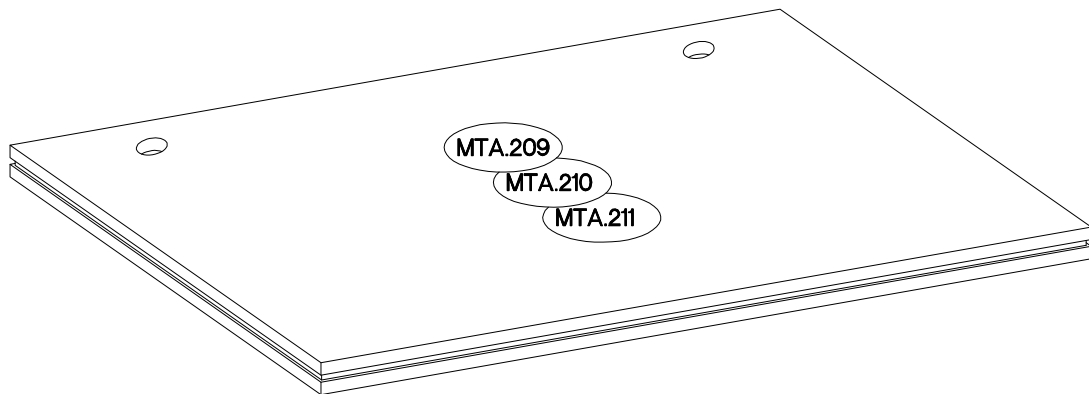

TYP 170

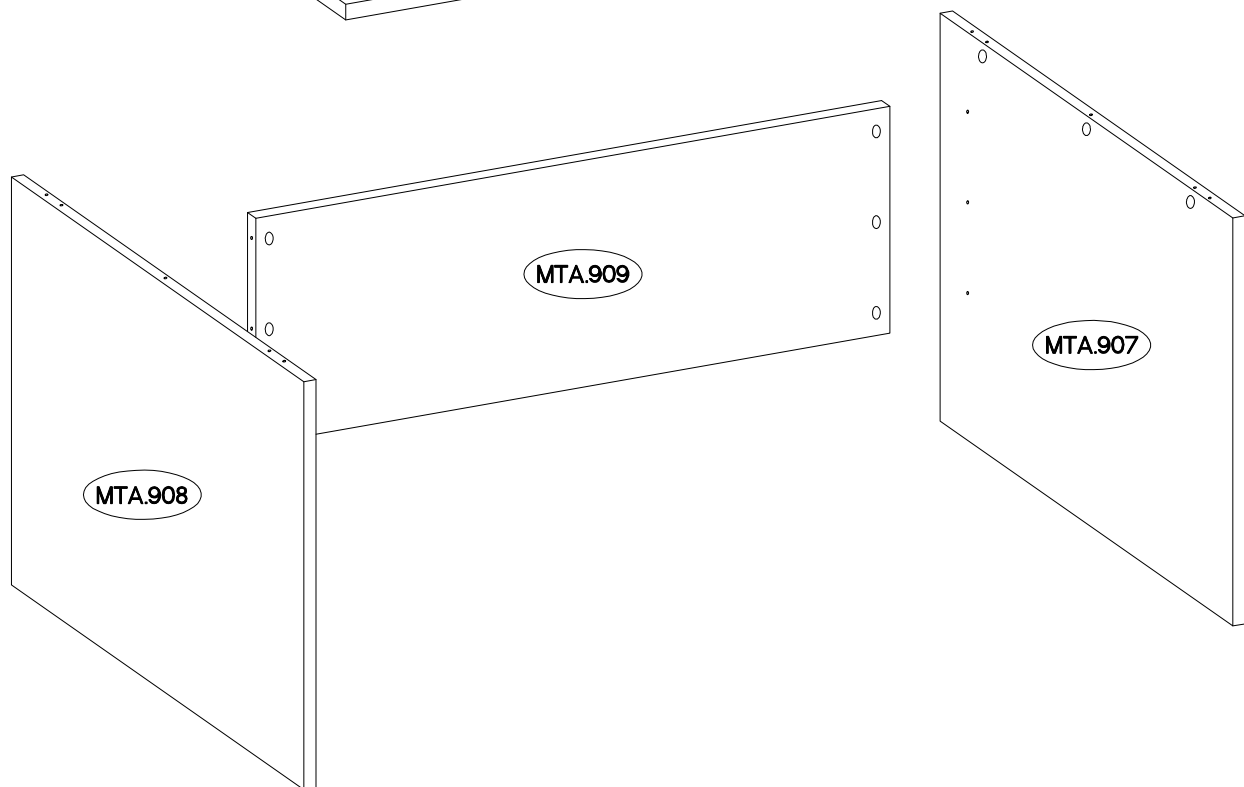
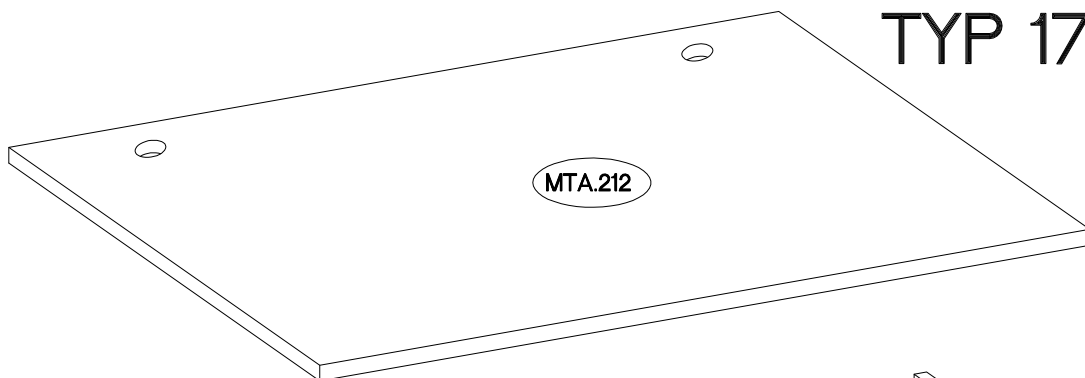





Ersatzteil Nummer	Dimension
MTA.907	720x630x22
MTA.908	720x630x22
MTA.909	1136x400x18

Ersatzteil Nummer	Dimension
MTA.209	1380x670x22
MTA.210	1370x660x12
MTA.211	1380x670x22

Ersatzteil Nummer	Dimension
MTA.212	1380x670x28

1

$\varnothing 8 \times 30 \text{mm}$  A 4	$6.5 \times 48 \times 16$  F2 4	$L=20 \text{mm}$  D2 6	$\varnothing 15 / 12 \text{mm}$  C 12
---	--	---	--

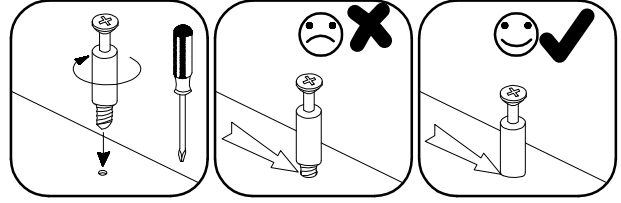
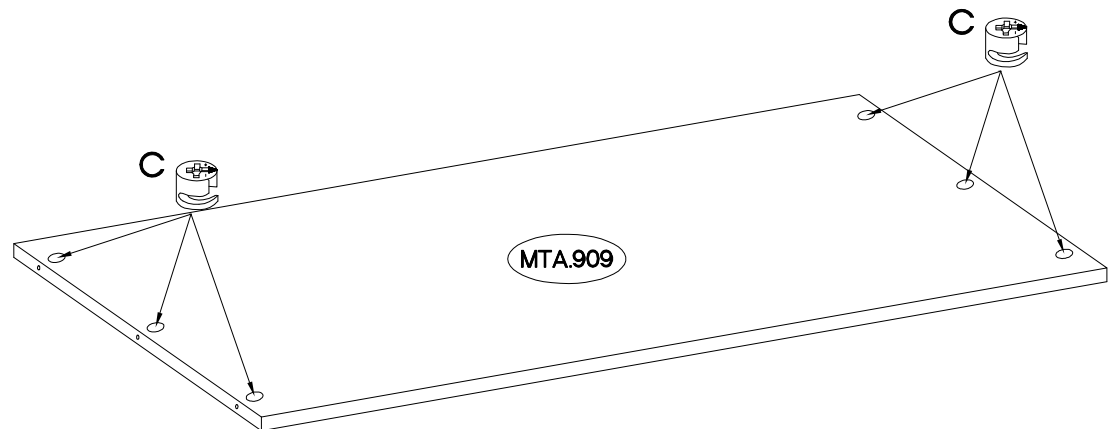
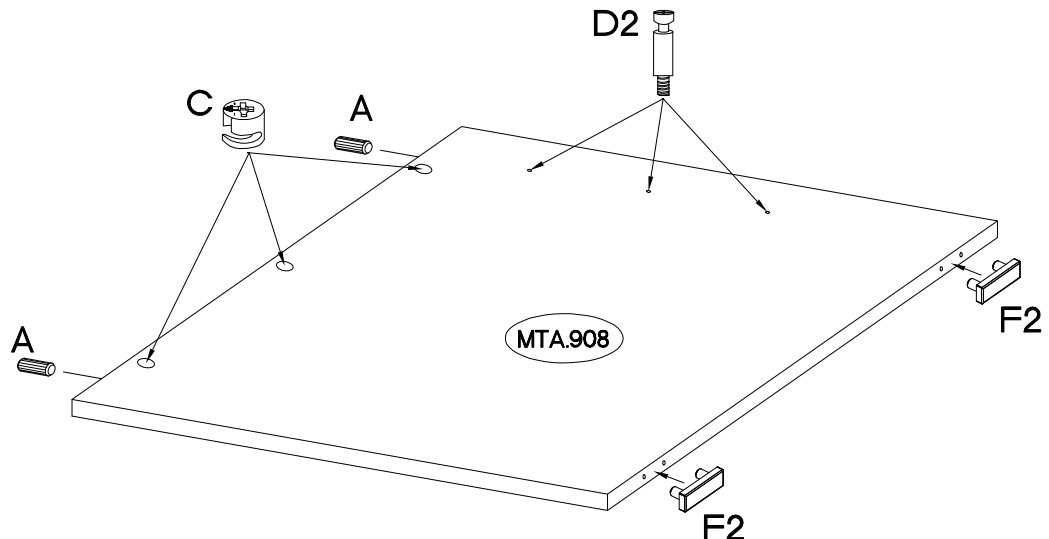
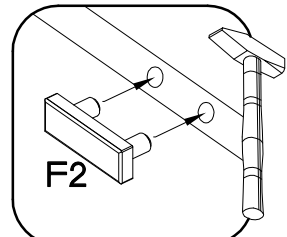
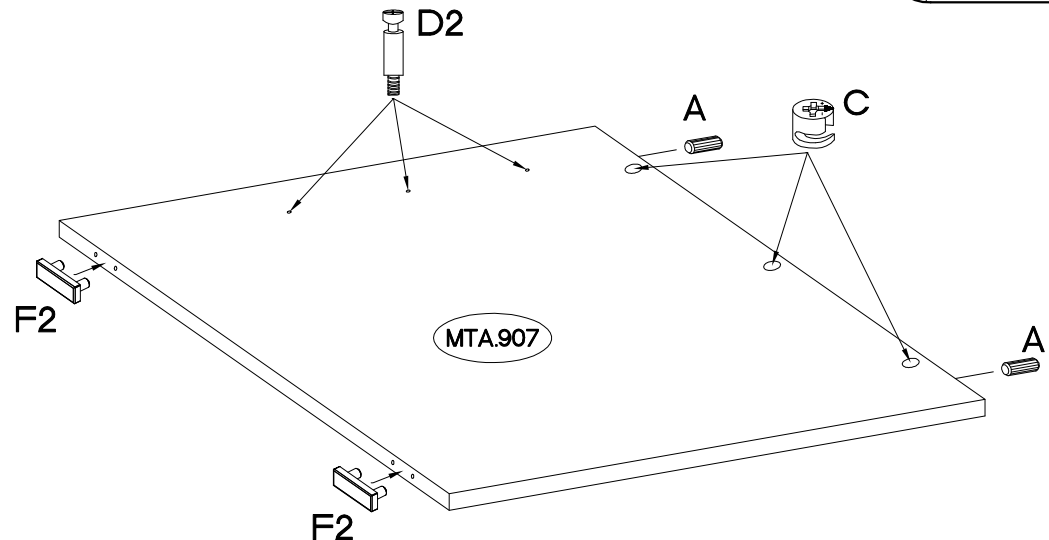
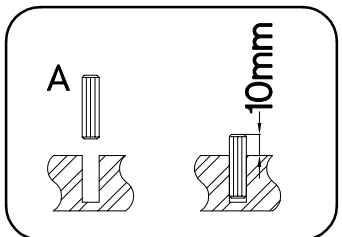
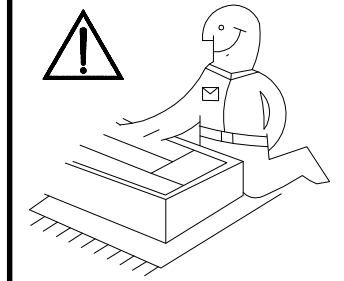
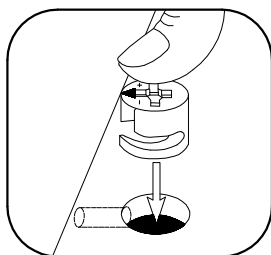

2

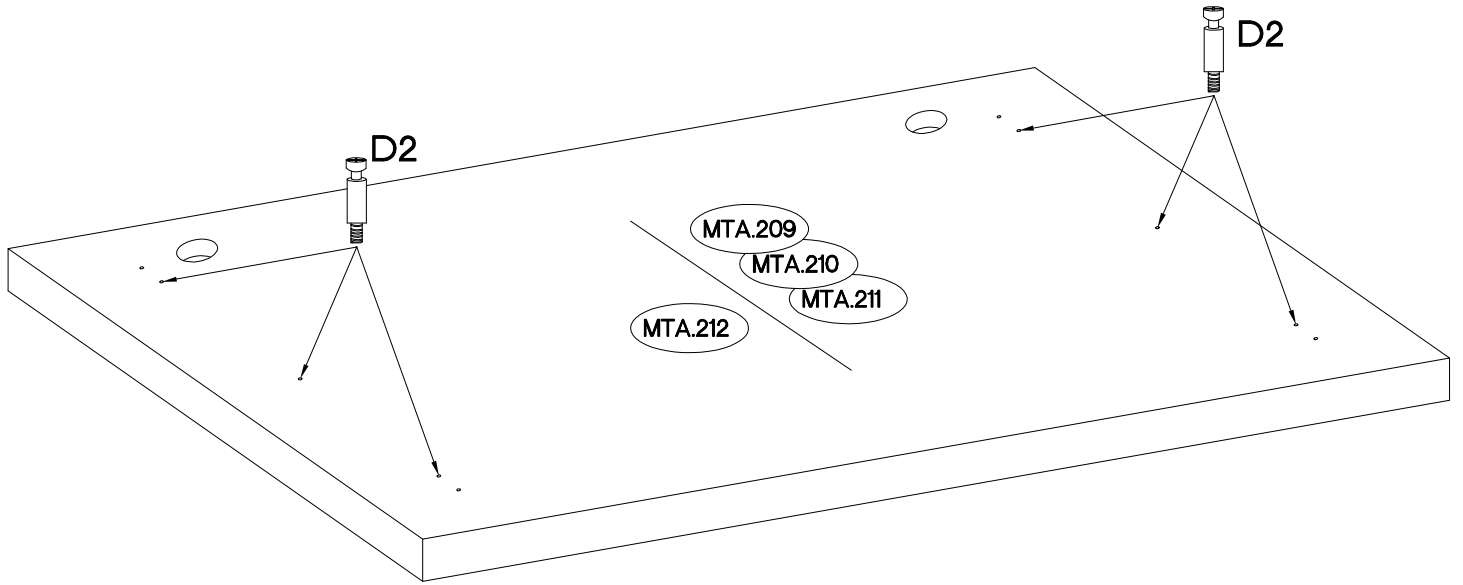
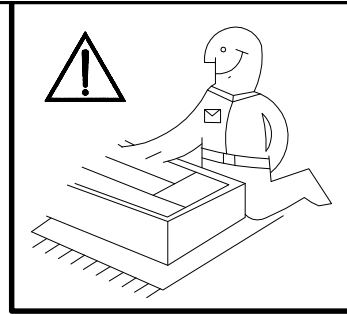
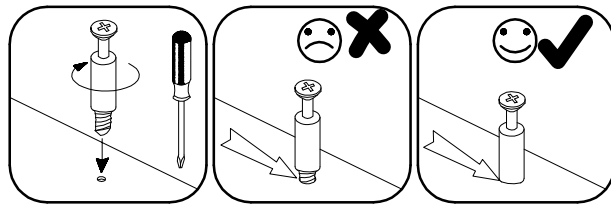
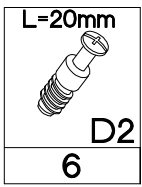

3

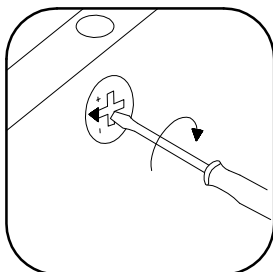
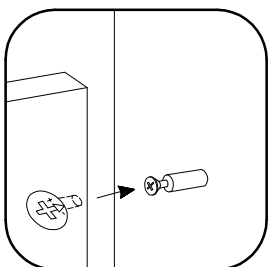
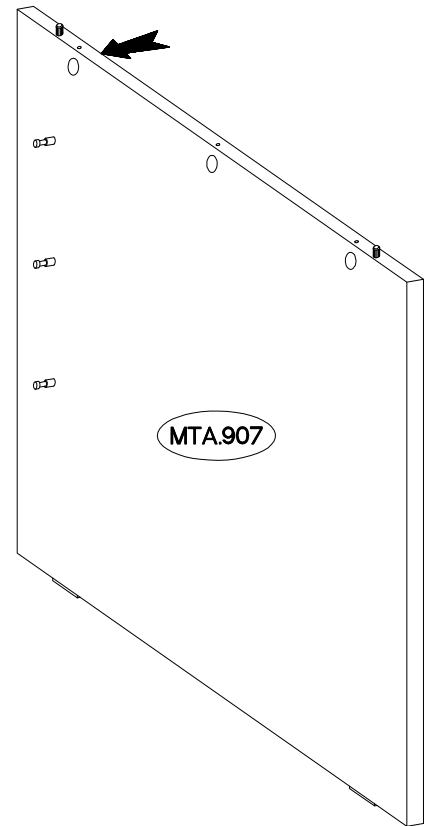
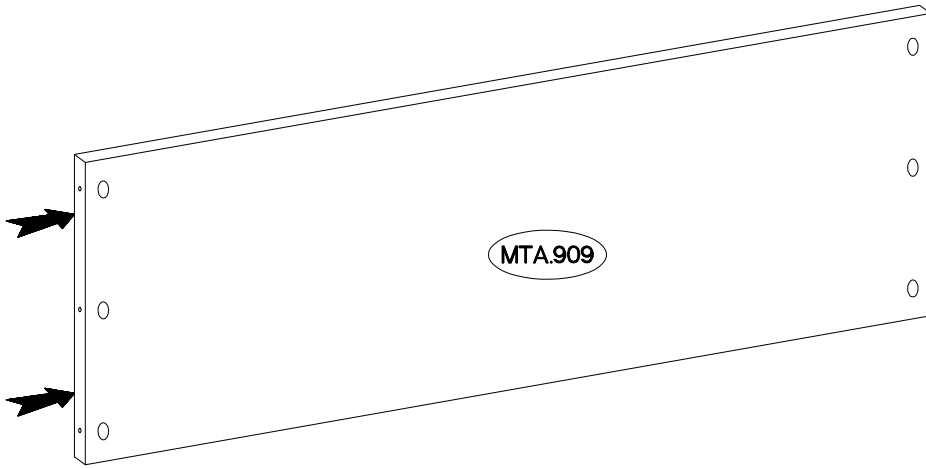

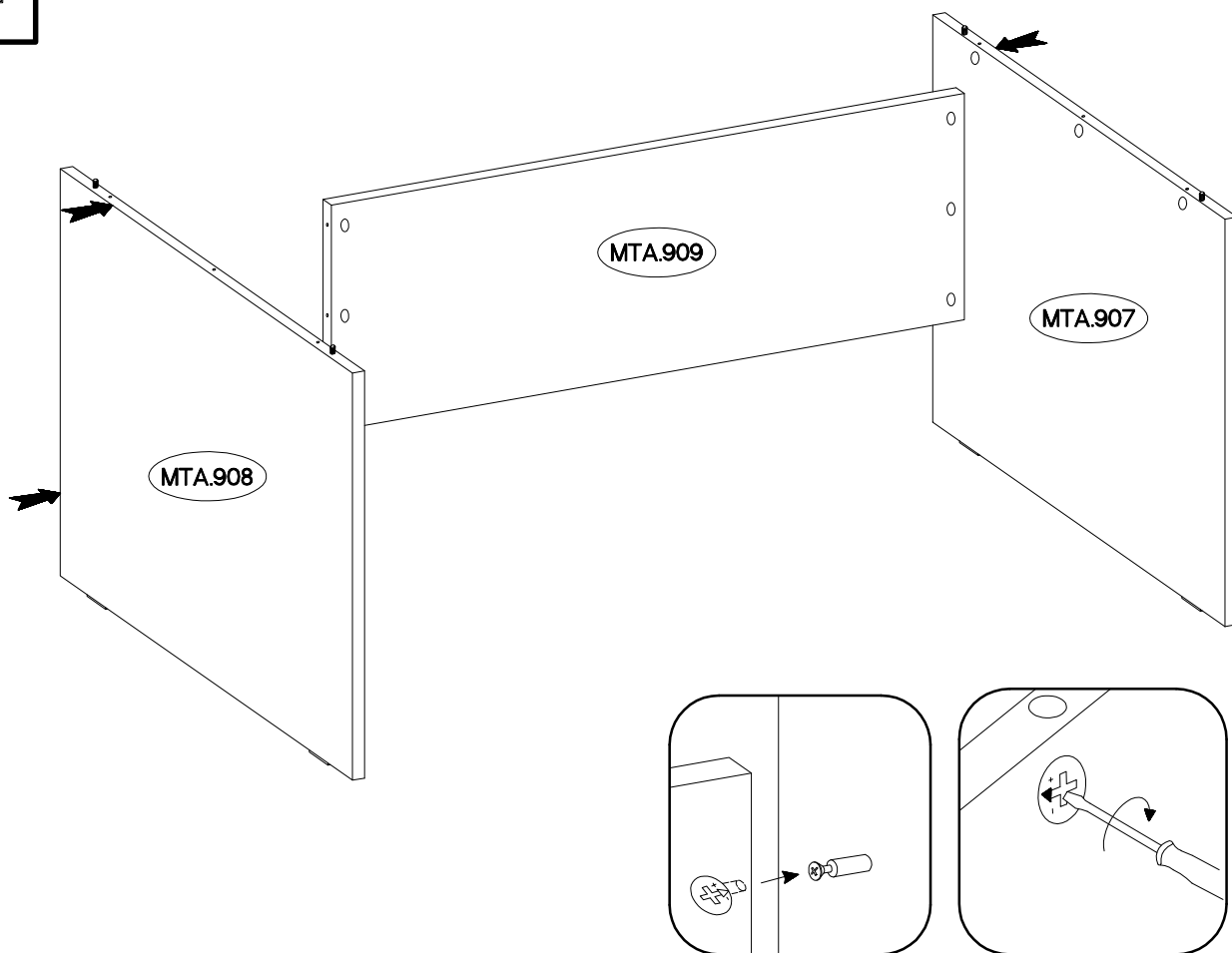

4

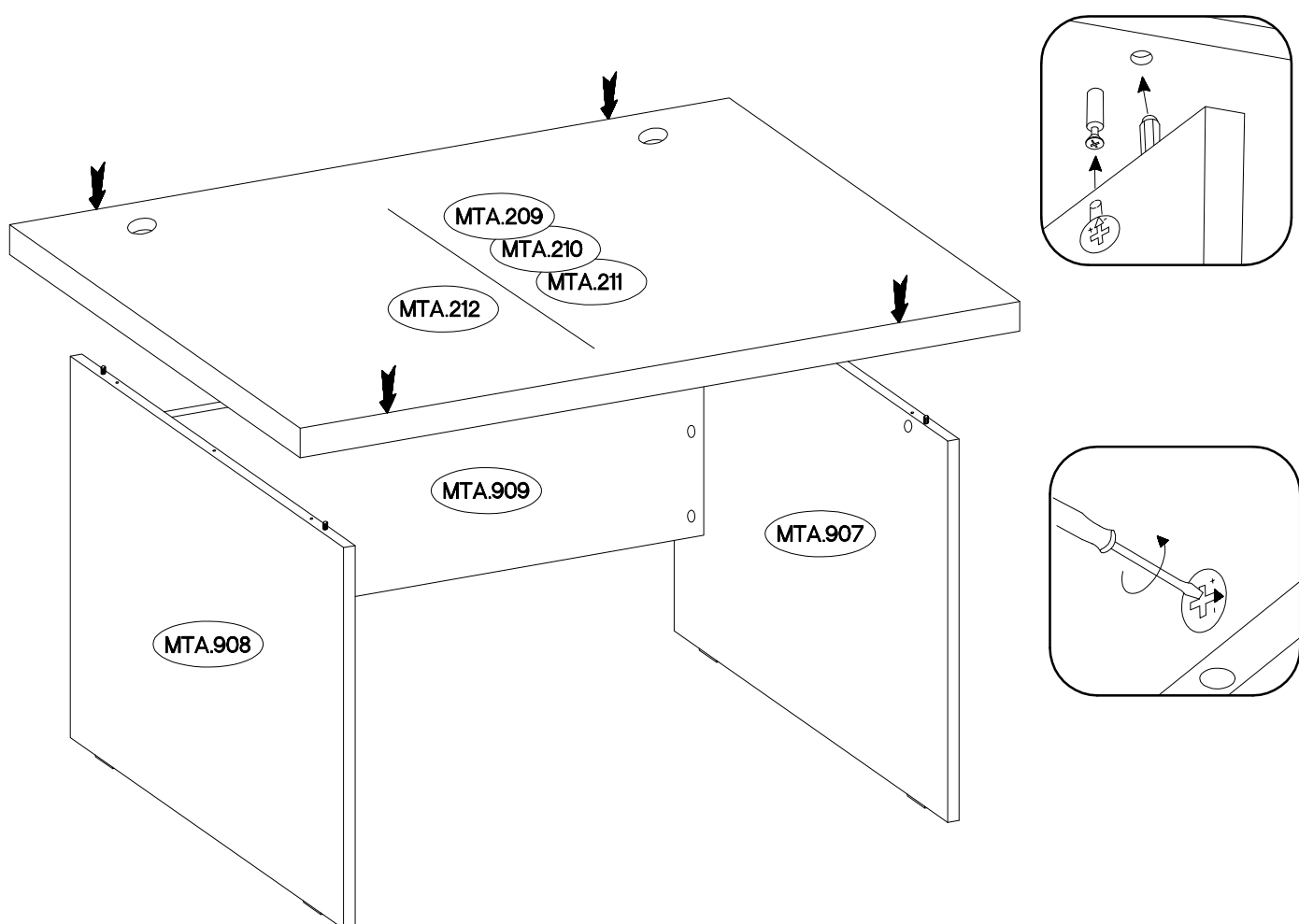

5



↑60  E8	↑20  E11
2	12

