

FRONT

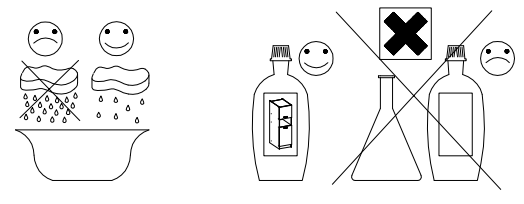

60 DK-2100 2F

60 LO-2100

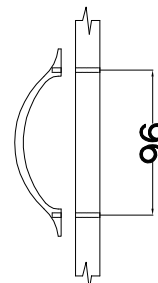
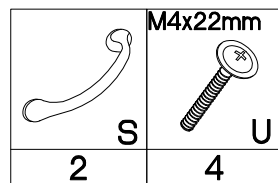
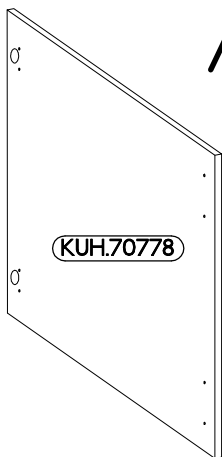
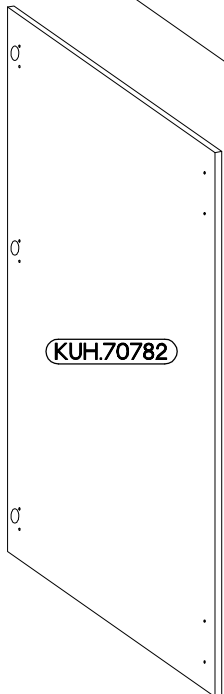
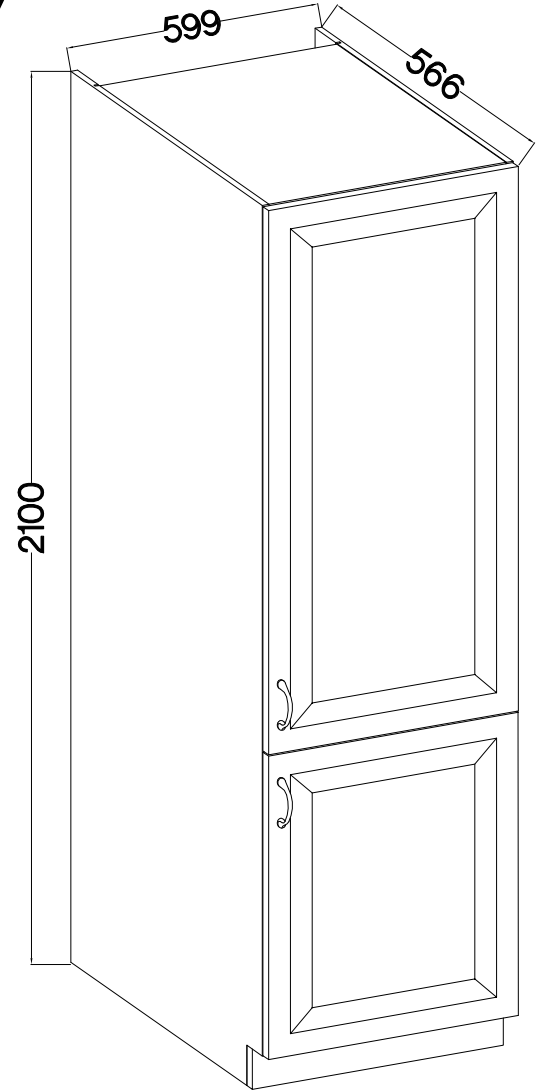
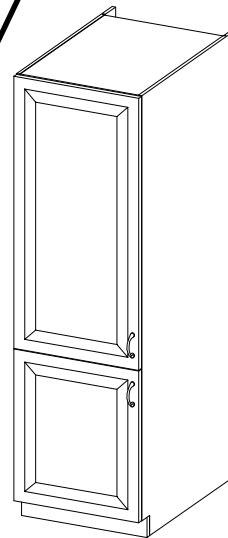
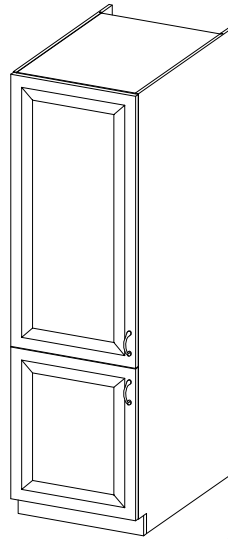
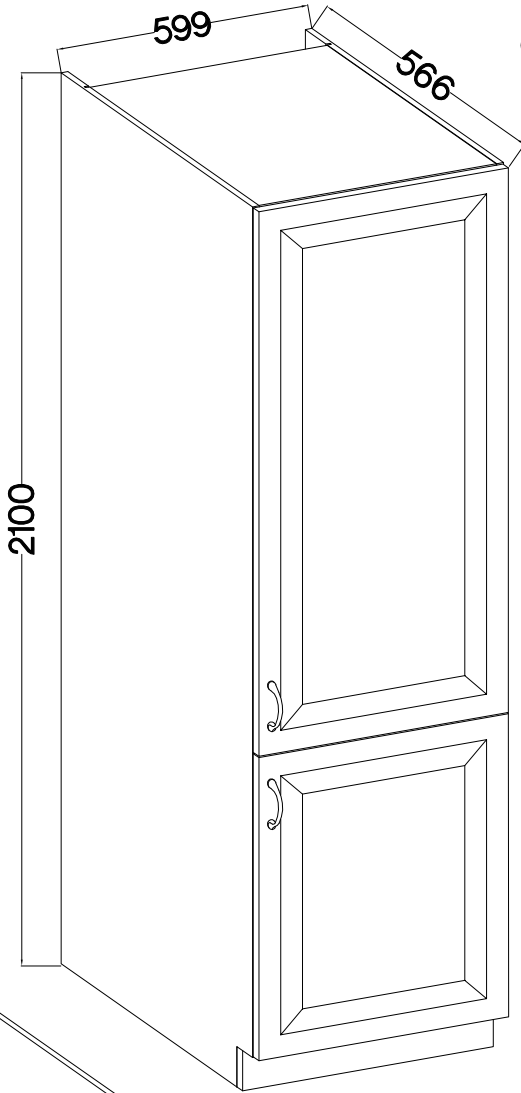

ISM-KUH-01205



1 60 DK-2100 2F

LEFT

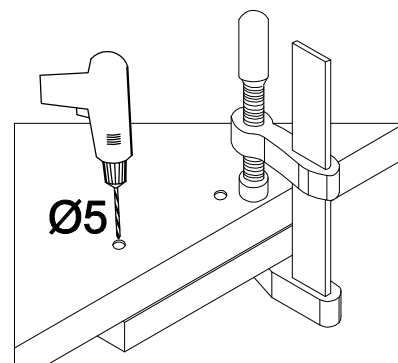
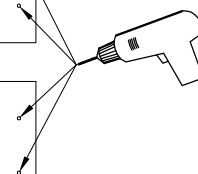
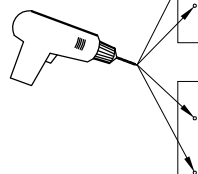
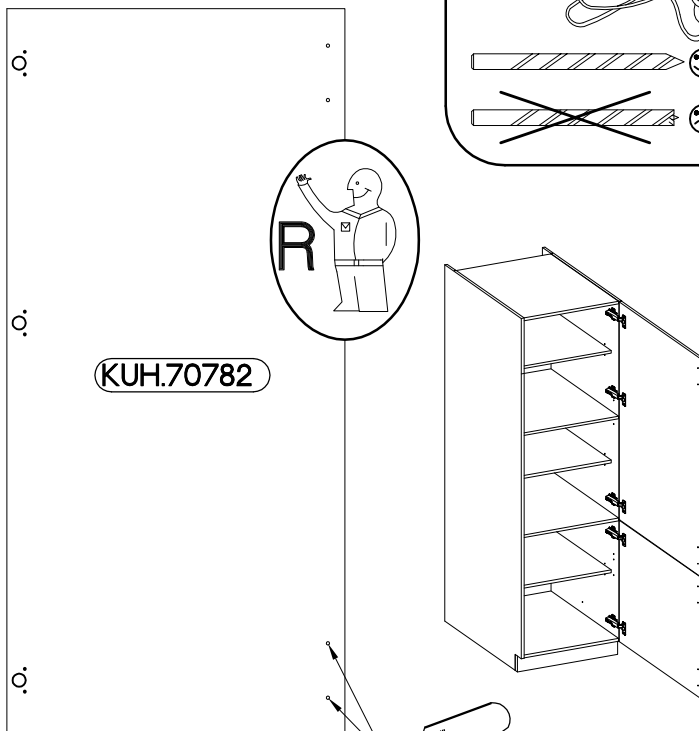
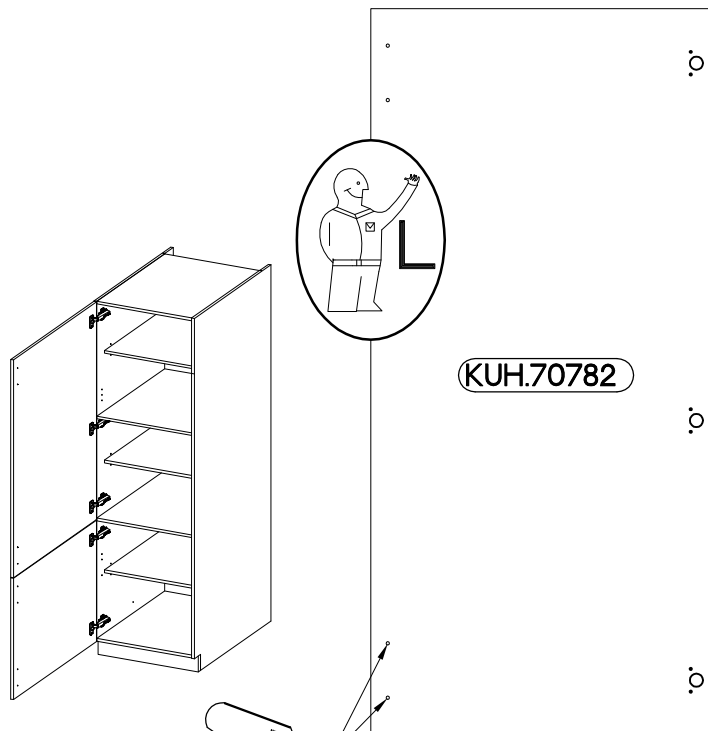
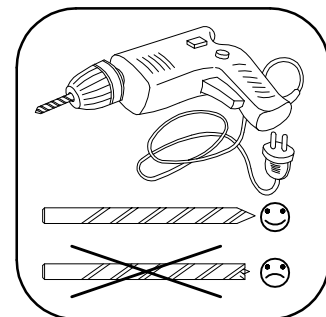
RIGHT



2

 †35/0mm HG 5	 †3.5x13mm P5 10
-----------------------------------------------------------------------------------------------------------	--------------------------------------------------------------------------------------------------------------

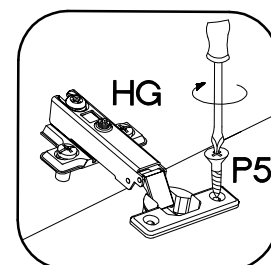
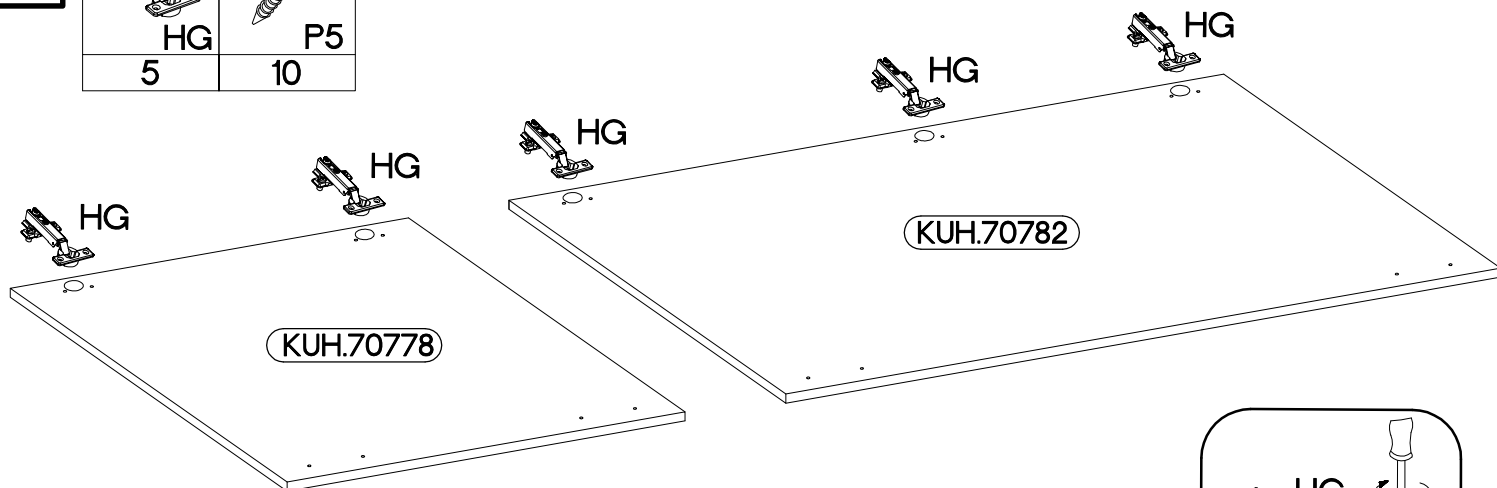

3

M4x22mm



U

4



S

2

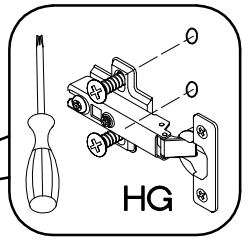

HG

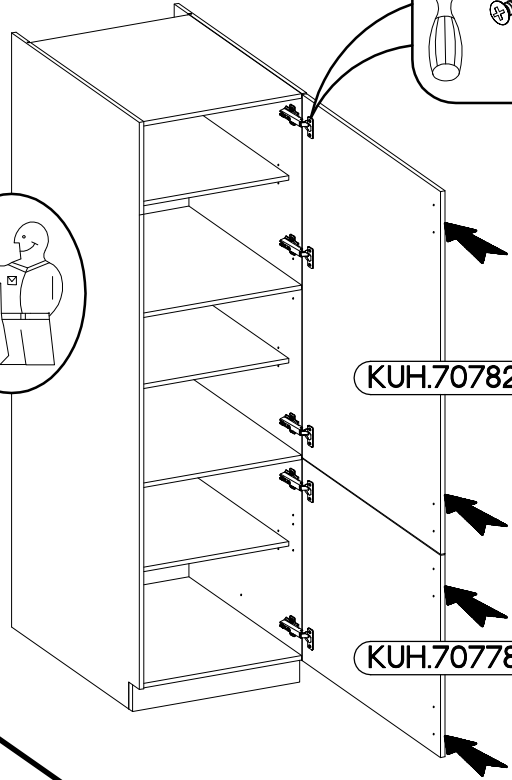

KUH.70782

KUH.70778

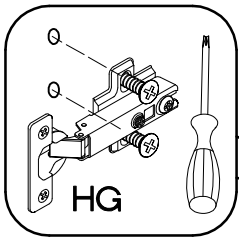

HG

KUH.70782

KUH.70778

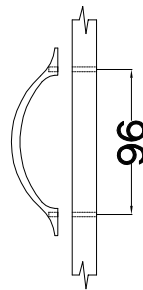
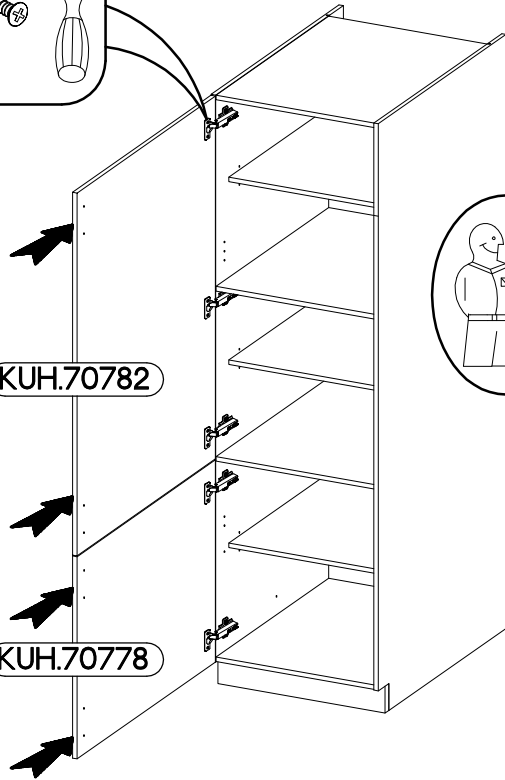
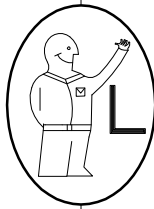

96

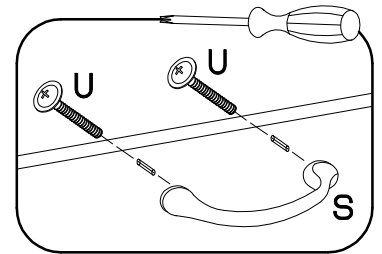

U

U

S

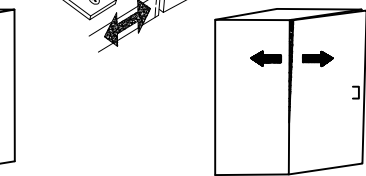
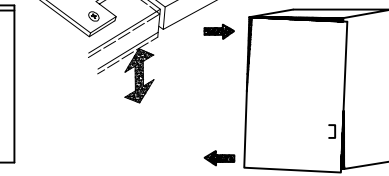
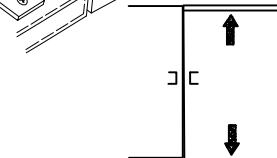
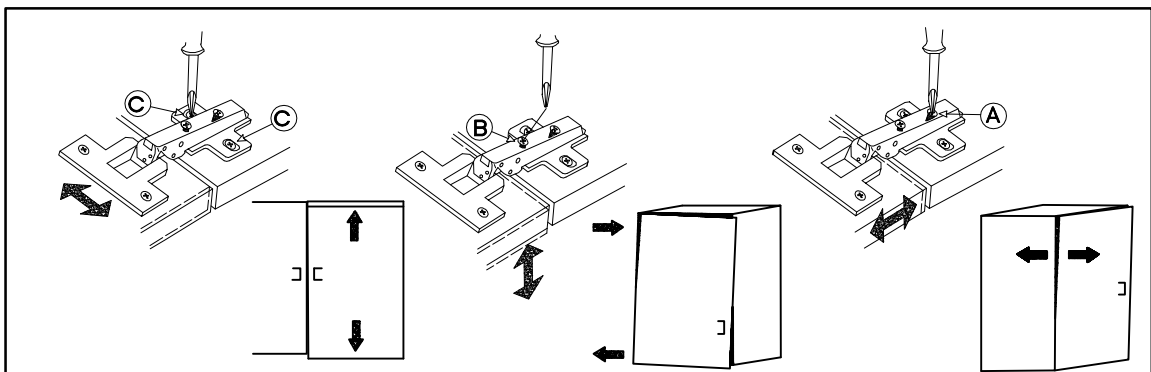

LEFT

RIGHT

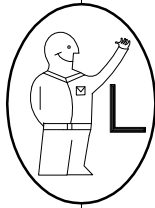
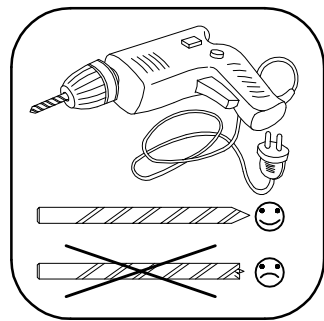

KUH.70782

KUH.70782

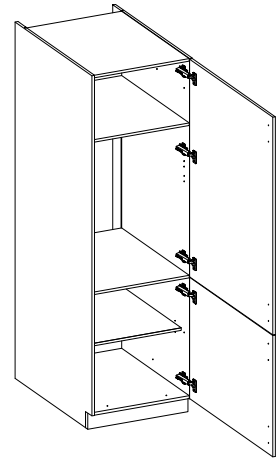
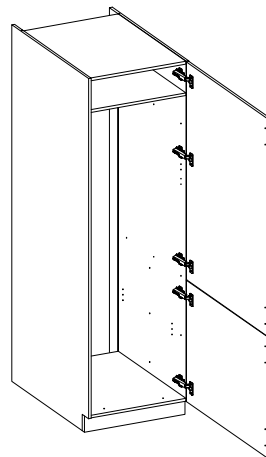
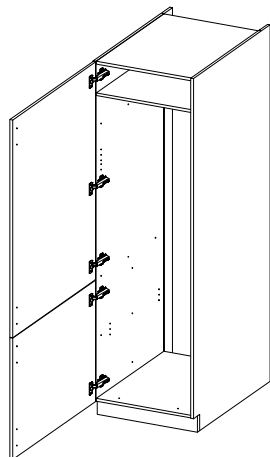
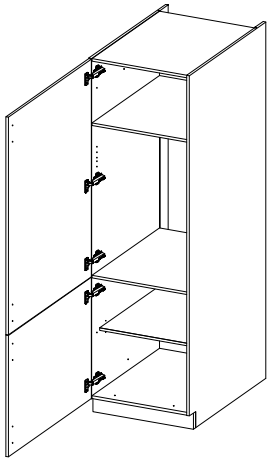
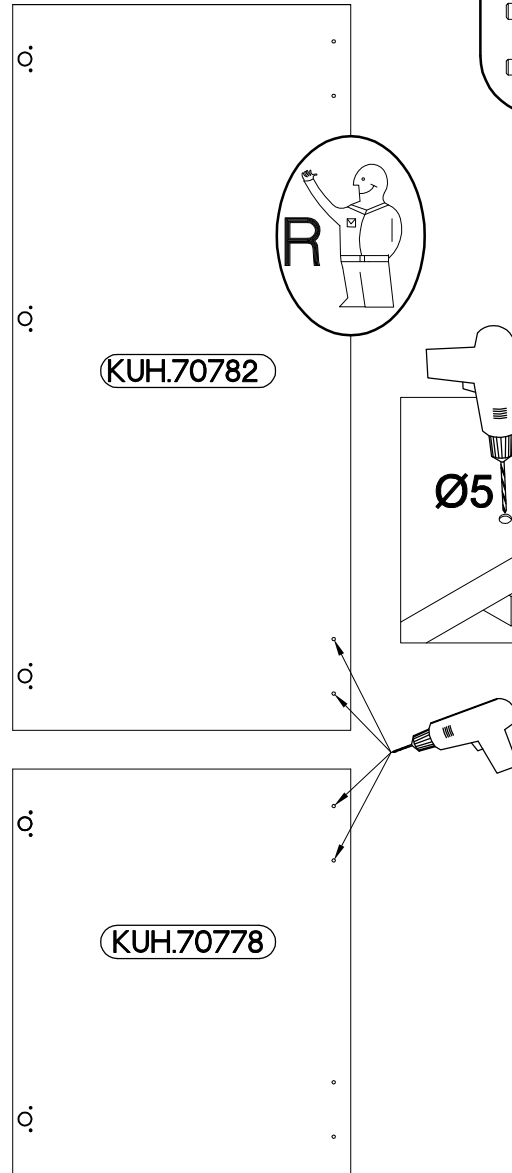
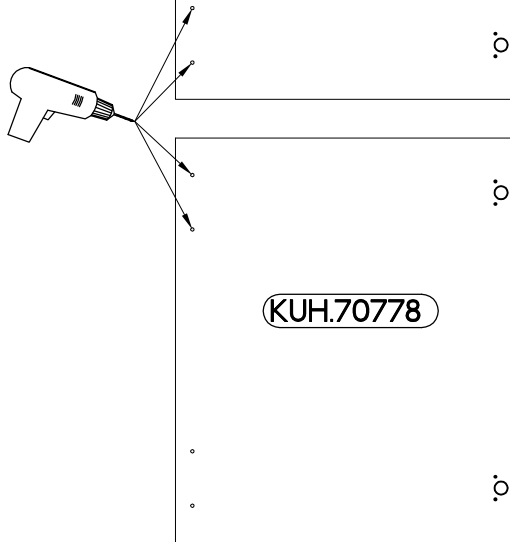
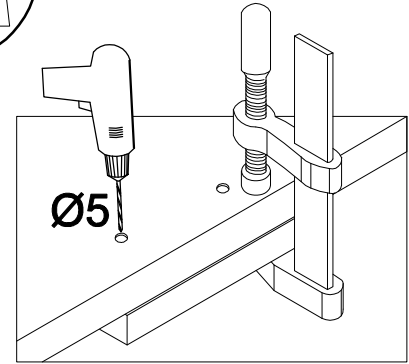

5

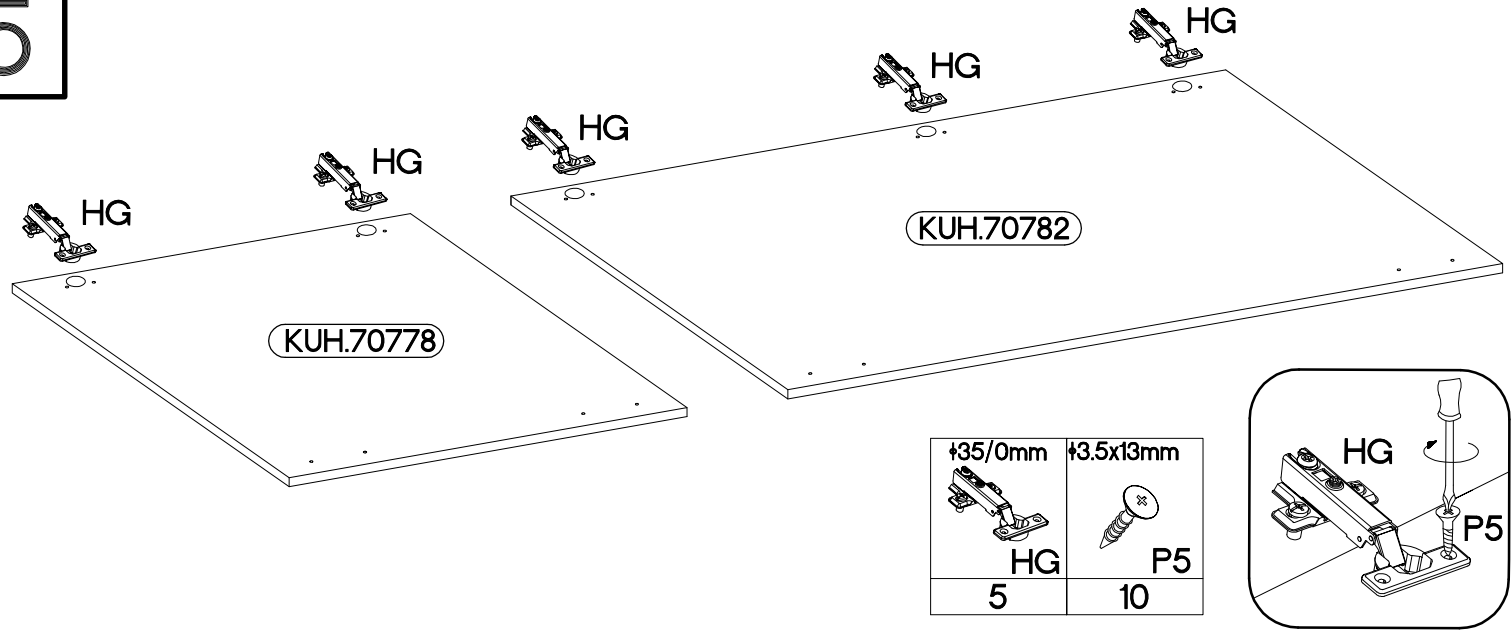

6 WARIANT A

M4x22mm U 4	S 2
-------------------	--------

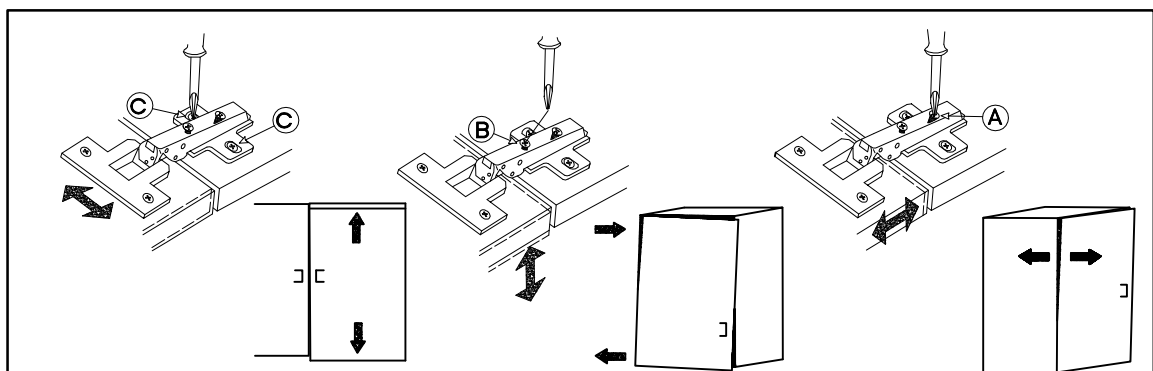
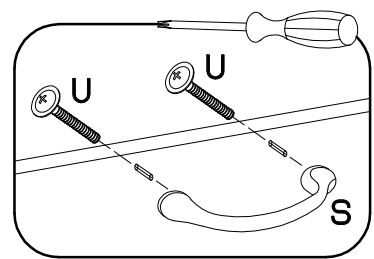
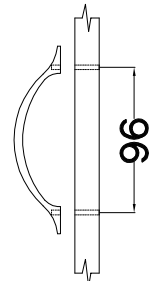
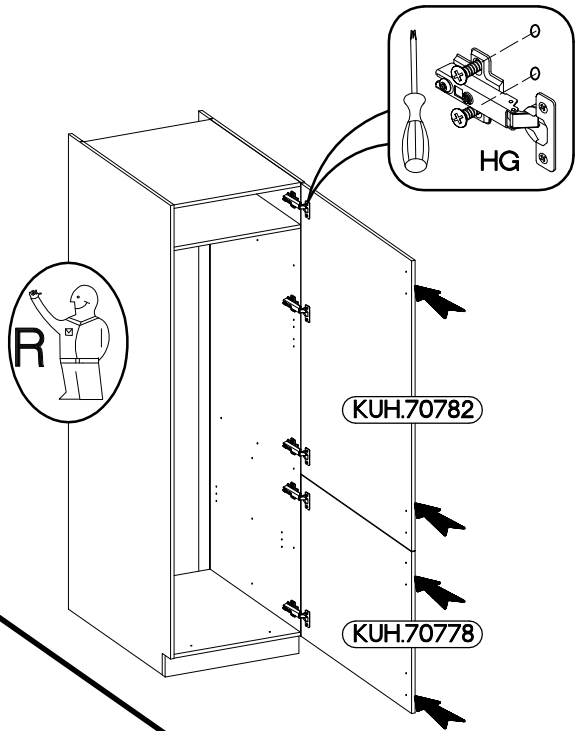
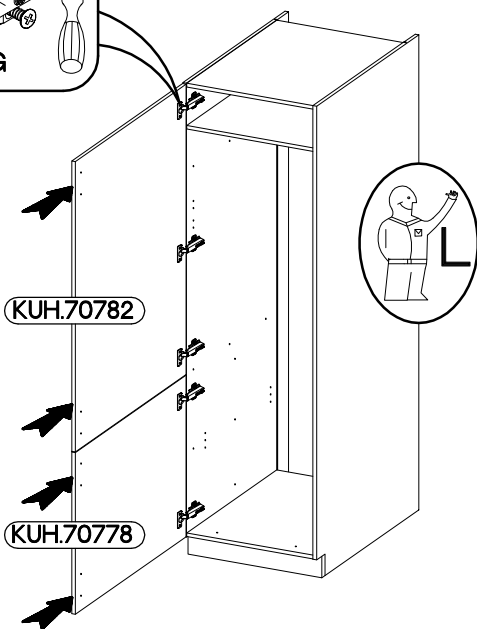
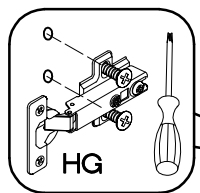

7

WARIANT B

M4x22mm



U

4



S

2

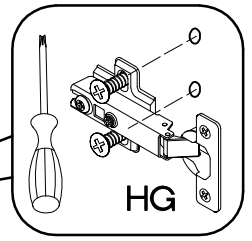

HG

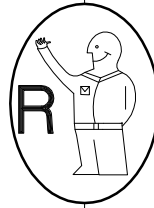

R

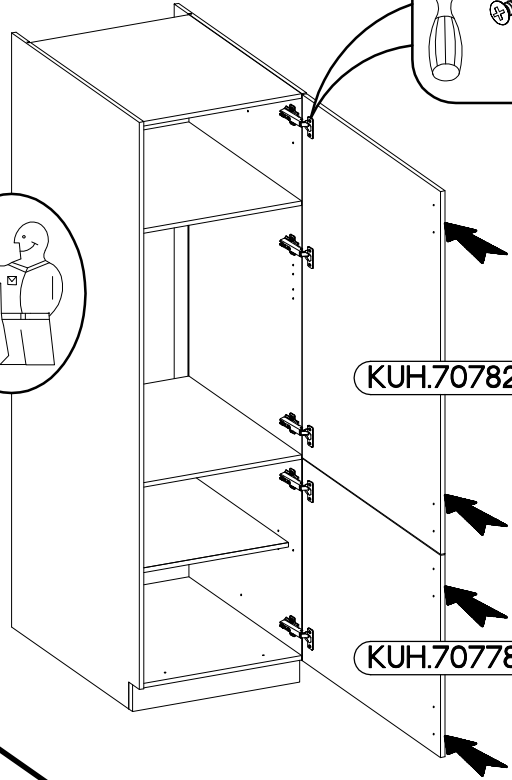

KUH.70782

KUH.70778

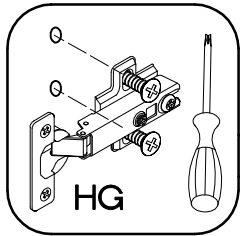

HG

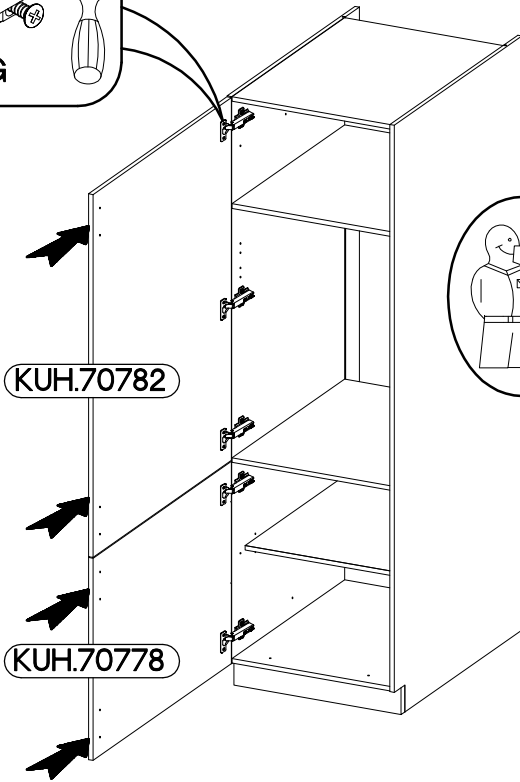

KUH.70782

KUH.70778

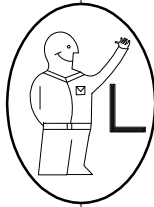

L

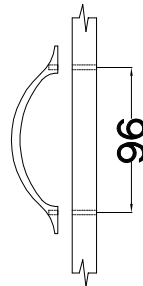

96

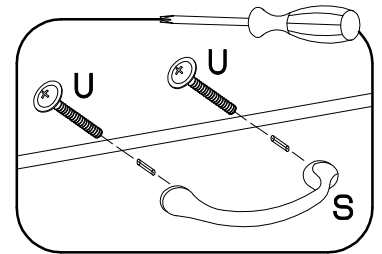

U

S

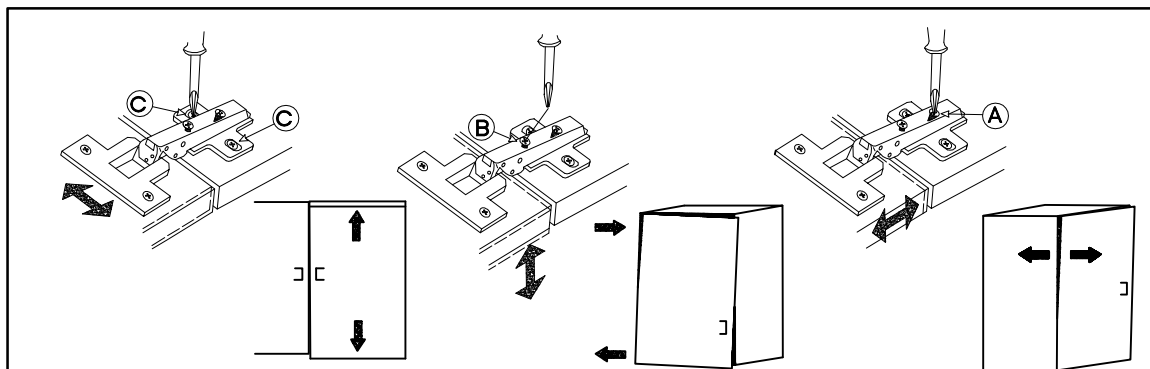

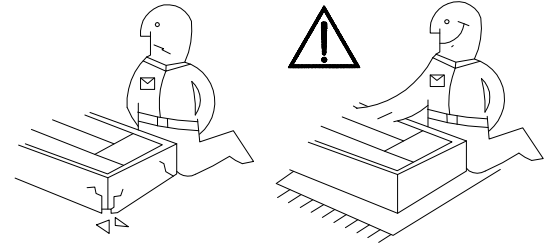
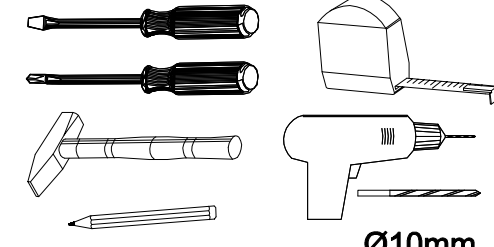
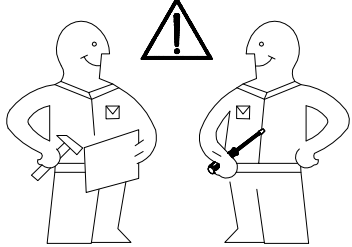

60 DP/DK-2100

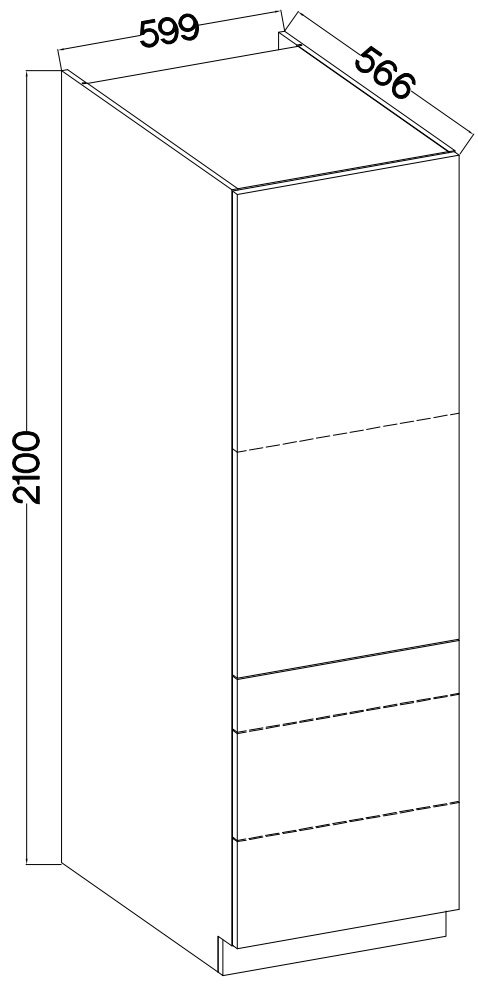
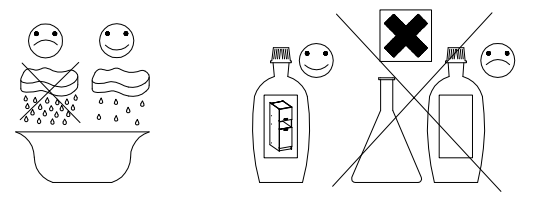

max. 10kg
 KUH.30002
 KUH.40007
 KUH.40008

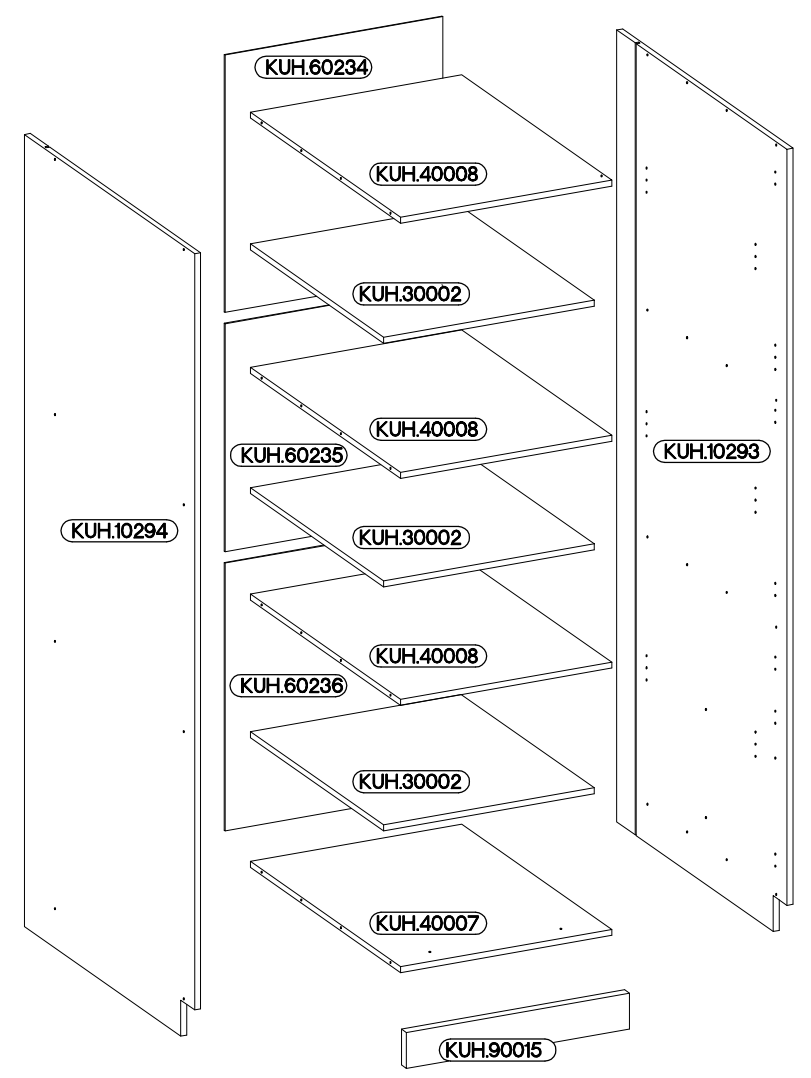
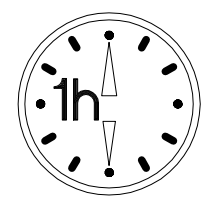

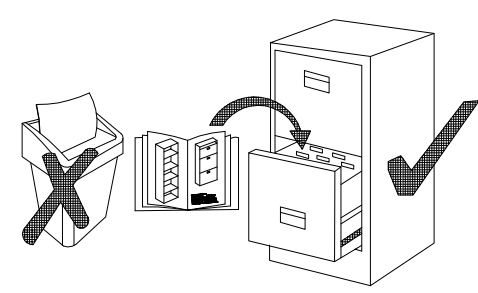

+8x30mm A 16	6,4 x 50mm B 16	E1 16	E9 2	6.5x48x16 F2 4	+35/0mm HG 5
+5/19mm J 12	L2 8	L25 1	O 1	+4.0x45mm P4 2	+3.5x13mm P5 12
				+3.0x20mm P7 15-20	

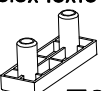

ISM-KUH-01147

1

6.5x48x16	+8x30mm
	
F2	A
4	16

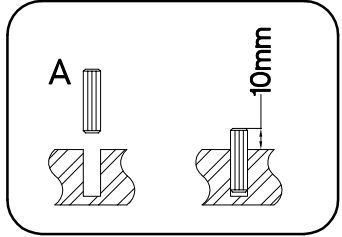
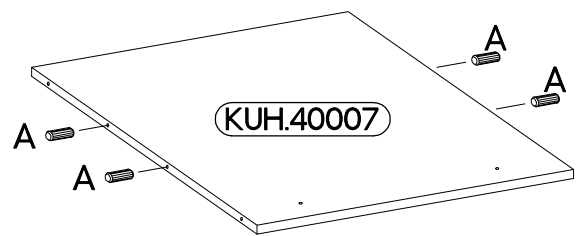
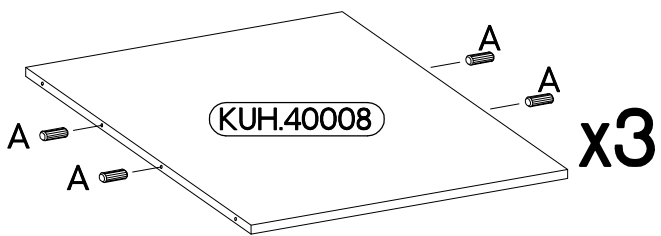
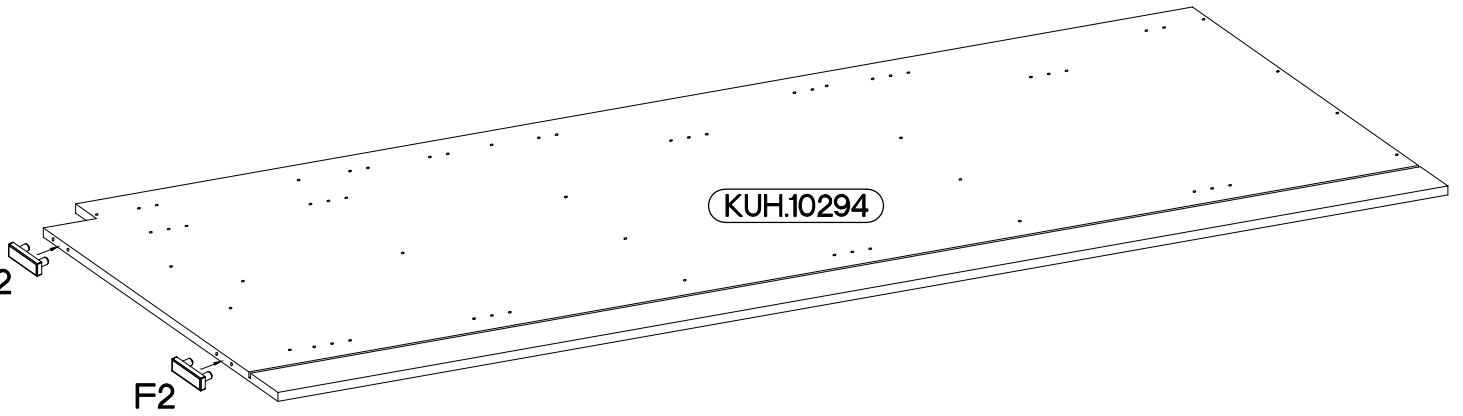
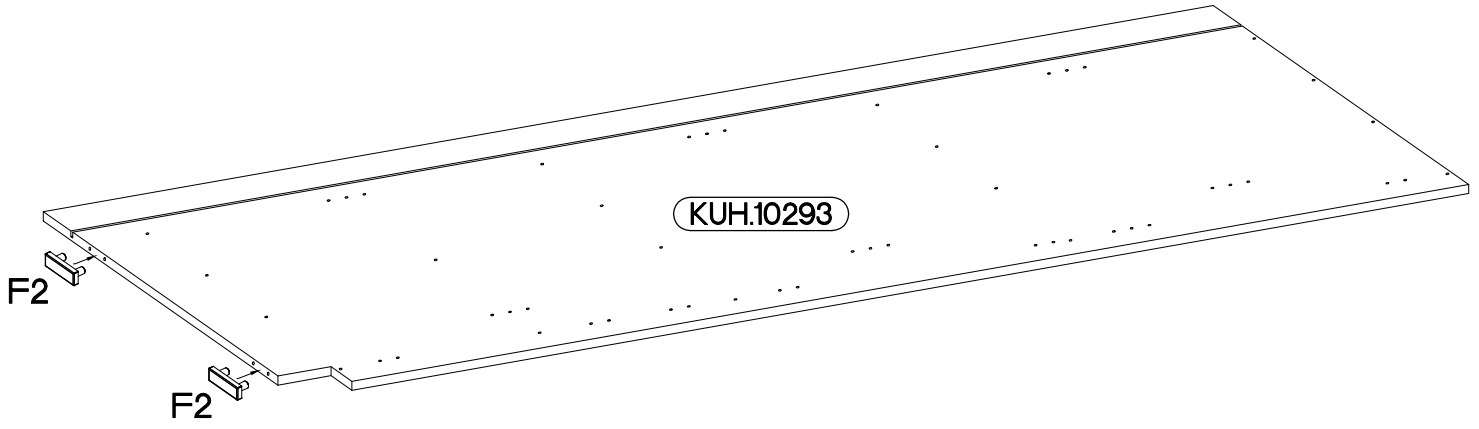
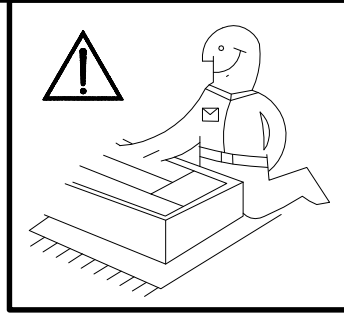
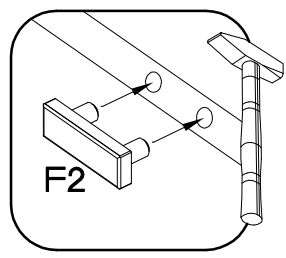

2

6,4 x 50mm

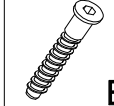

B

8

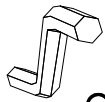

O

1



E1

8

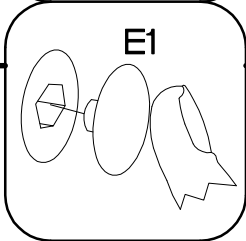
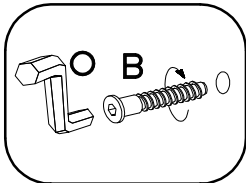
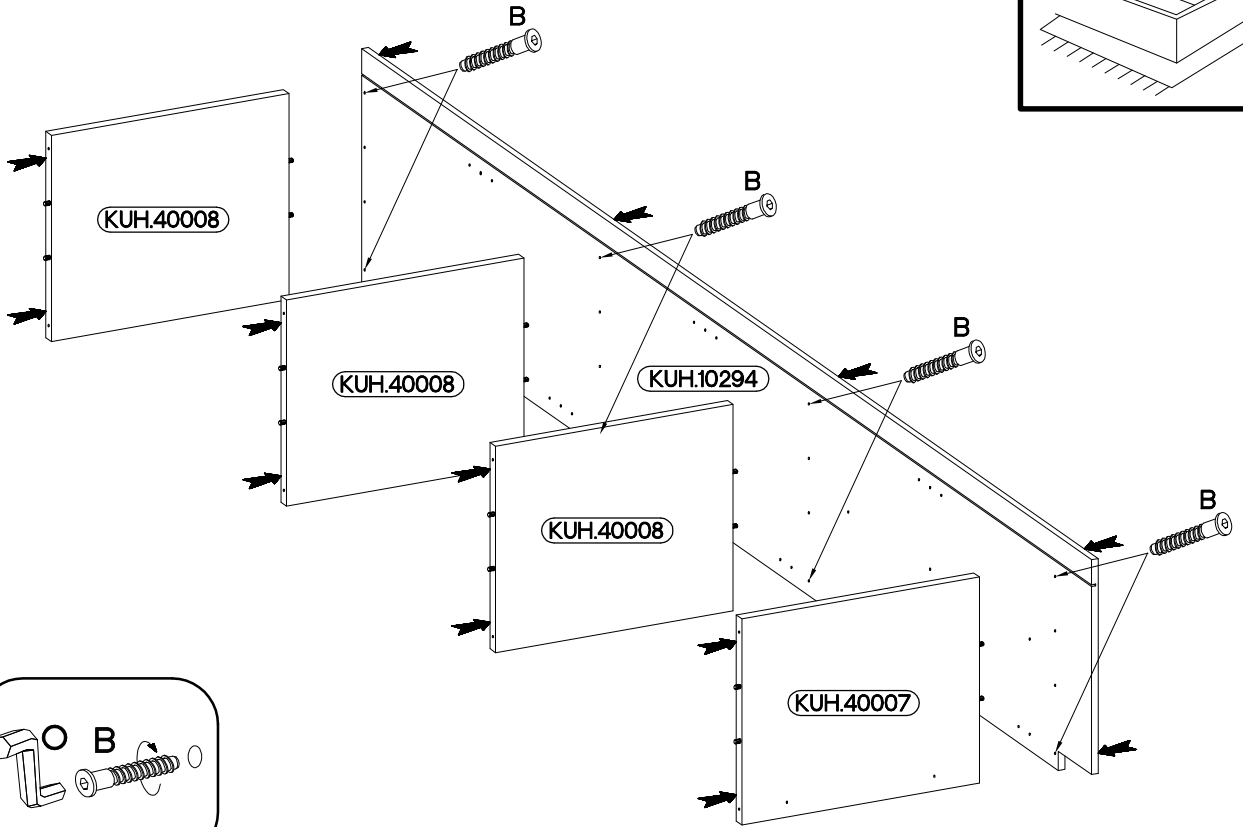
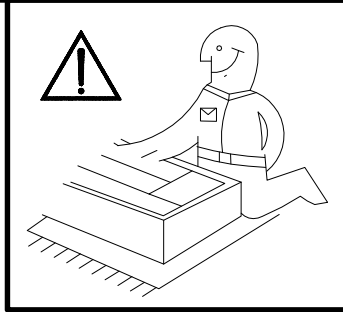

3

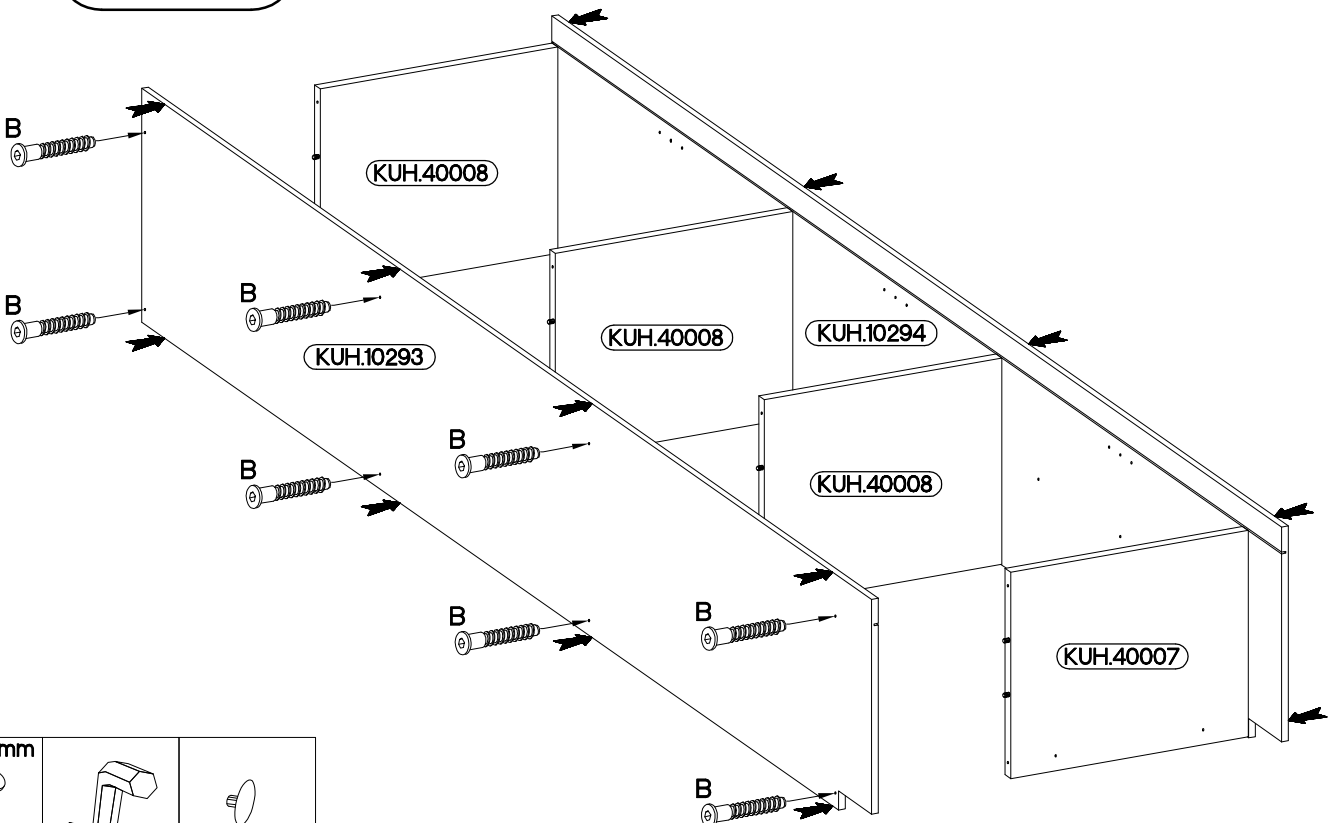

6,4 x 50mm

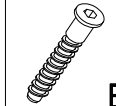

B

8

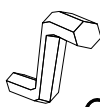

O

1



E1

8

60 DP-2100 2F

60 DPS-2100 1F 3S

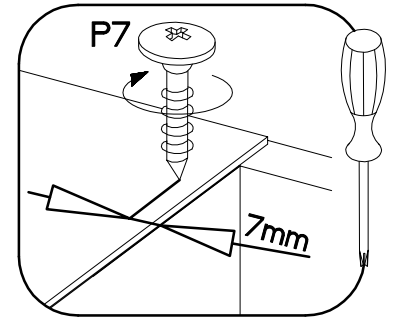
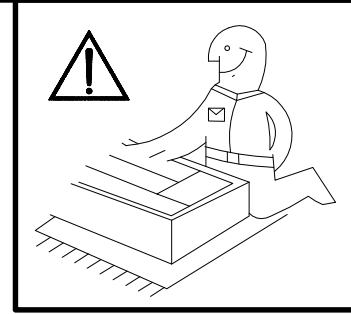
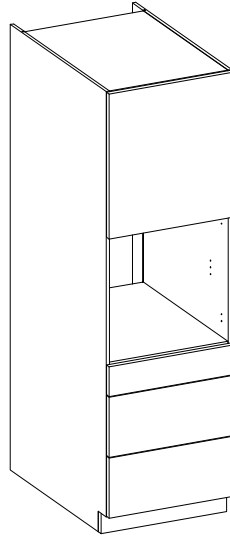
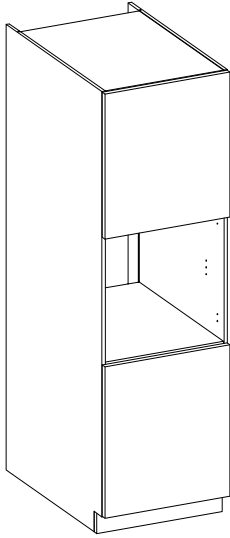

4

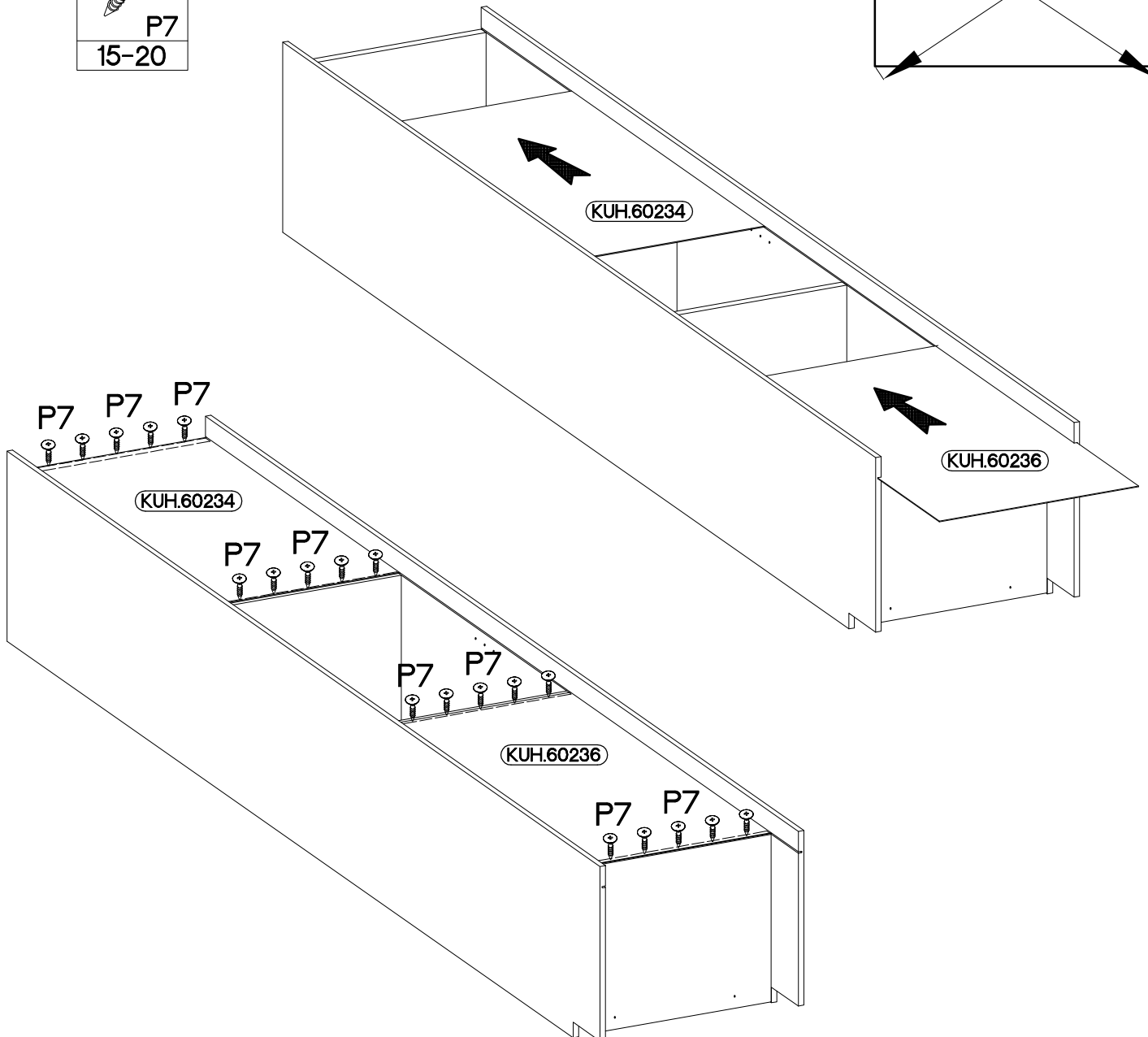
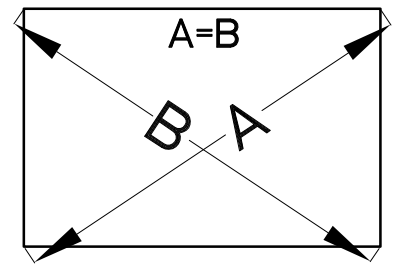
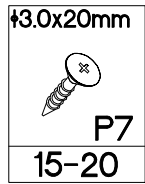

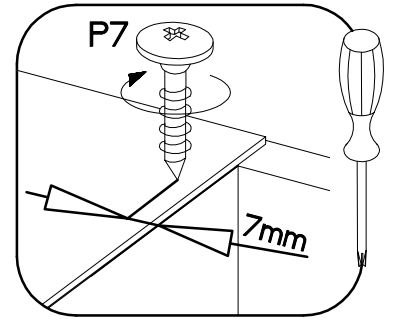
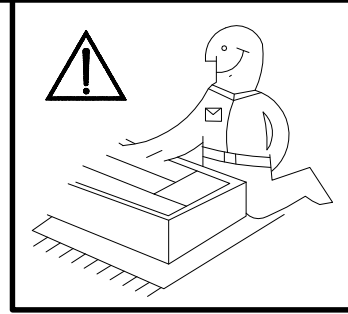
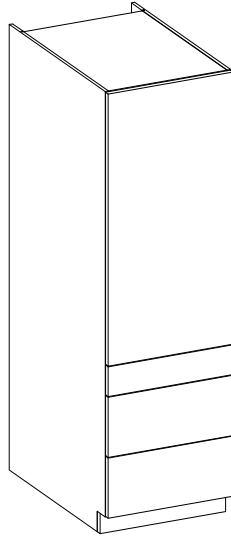
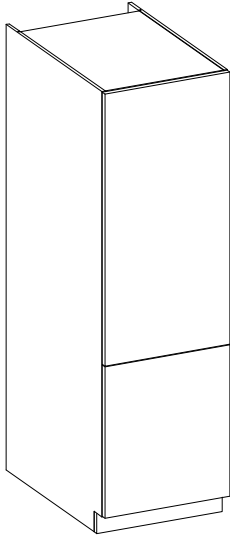

60 DK-2100 2F

60 DKS-2100 1F 3S

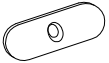

5

$\pm 3.0 \times 20 \text{mm}$	
	L2
P7	8
15-20	

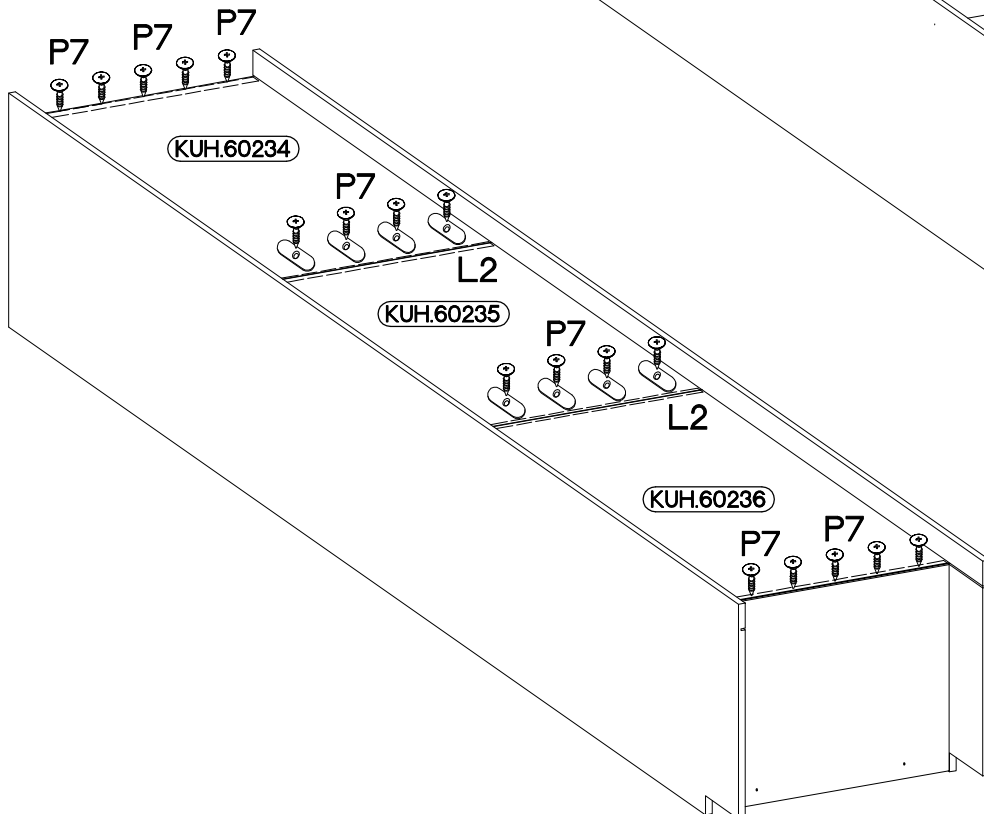
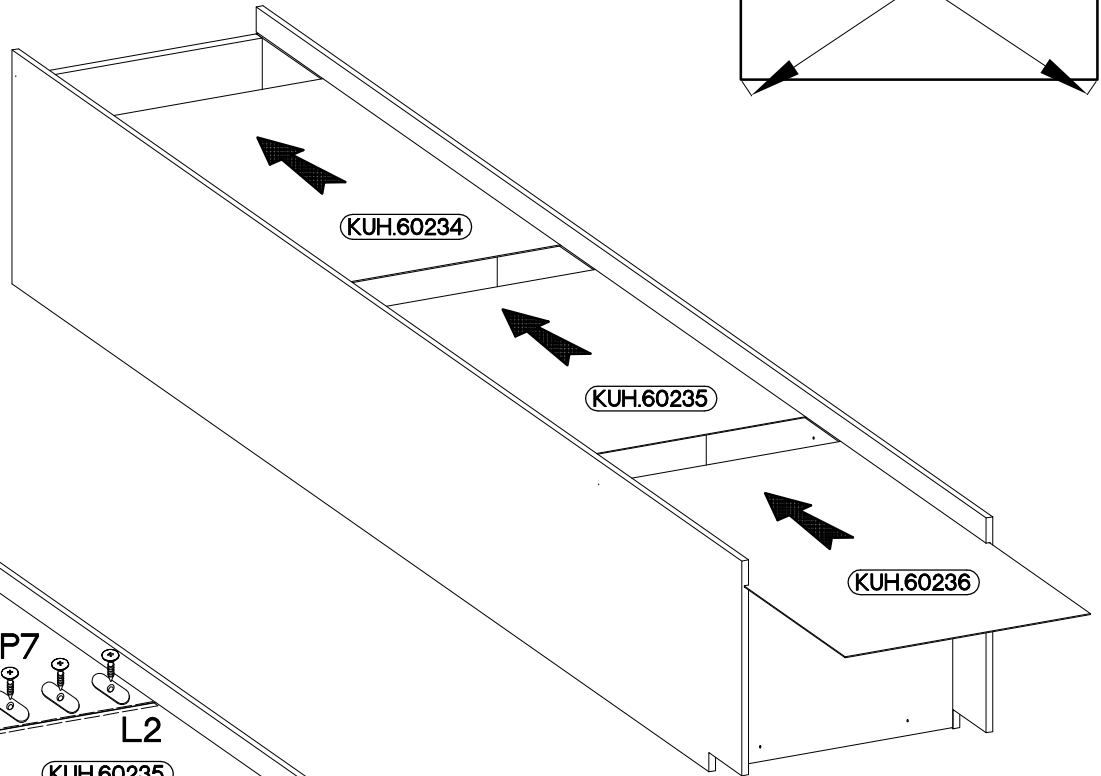
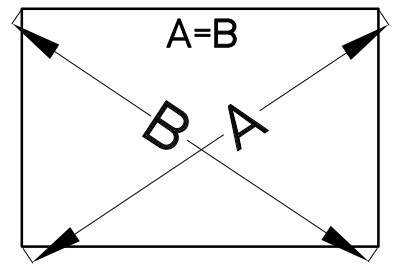

6

+4.0x45mm



P4

2



E9

2

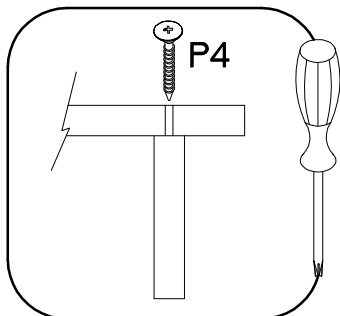
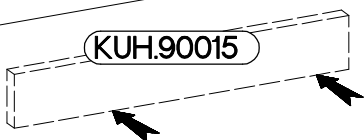
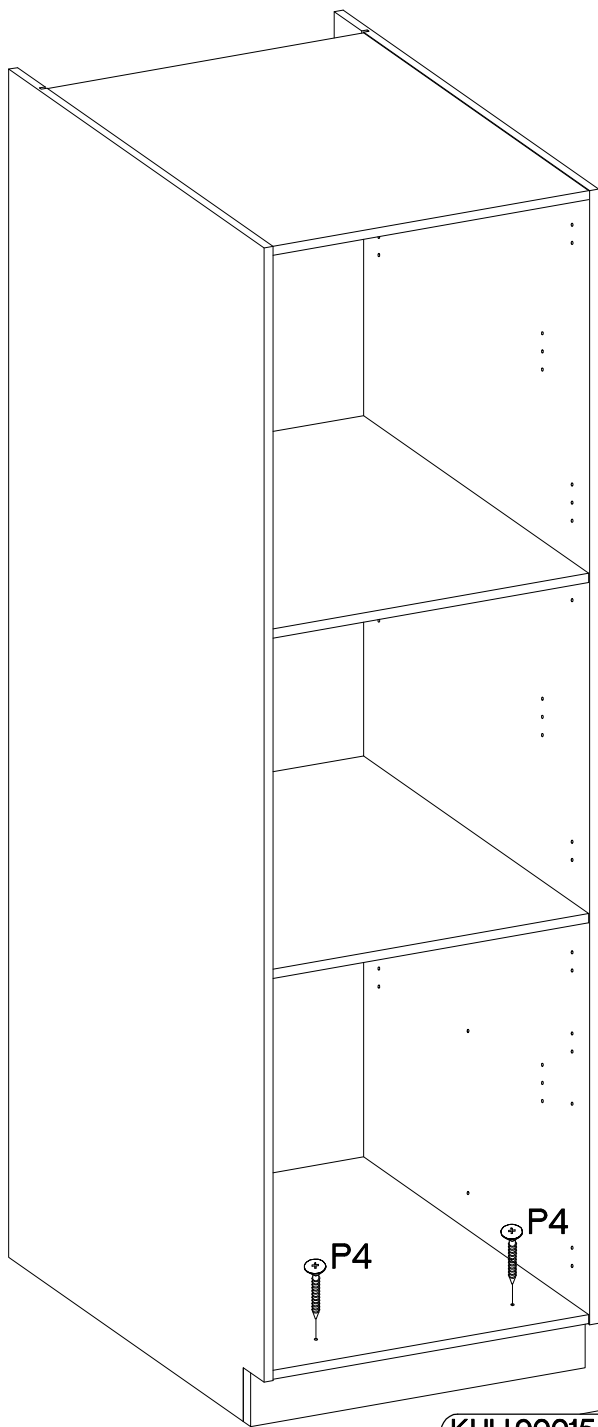

7



+5/19mm

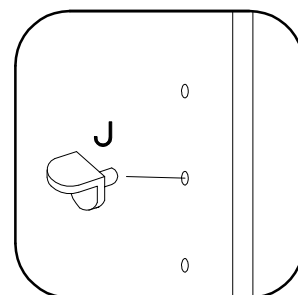
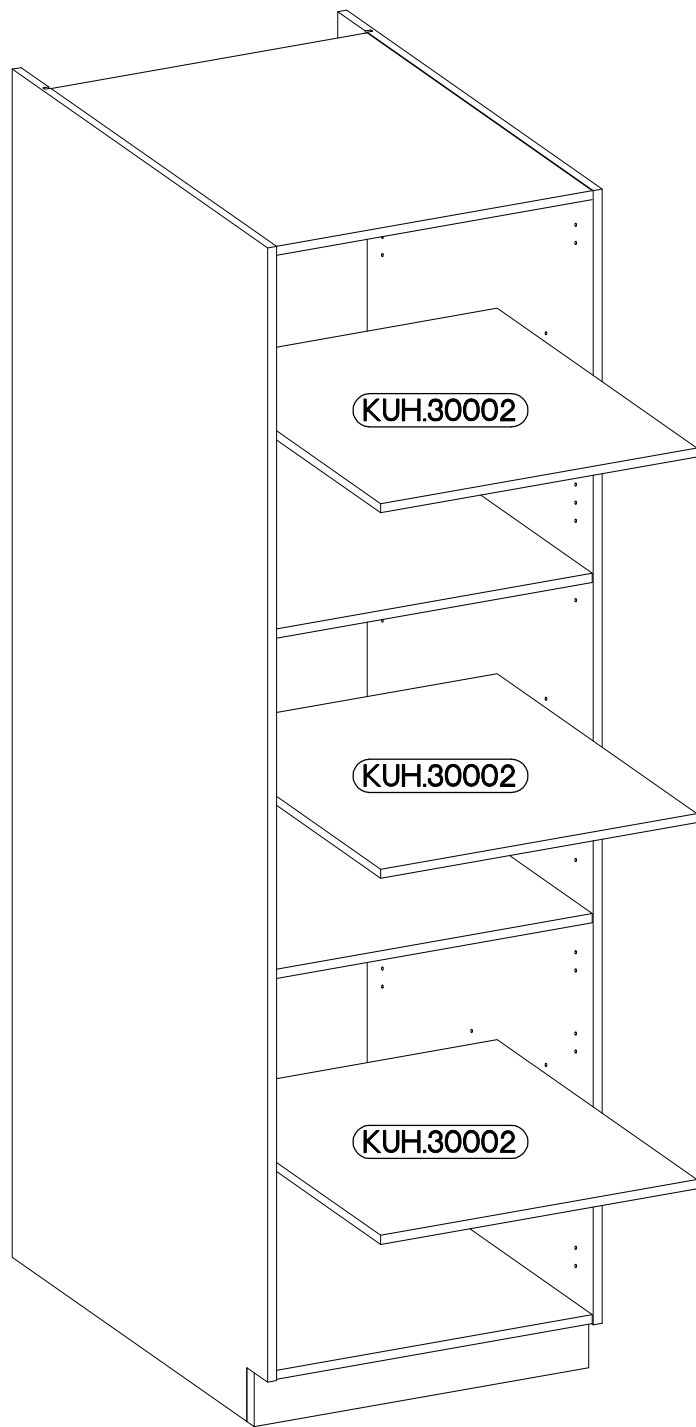

J

12

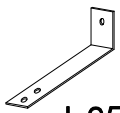

 L25 1	$\pm 3.5 \times 13 \text{mm}$  P5 2
----------------------------------------------------------------------------------------------	------------------------------------------------------------------------------------------------------------------------------

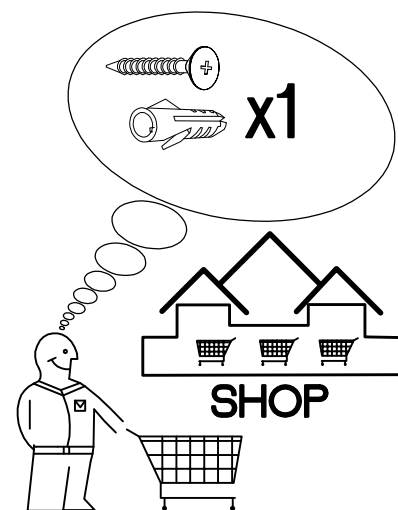
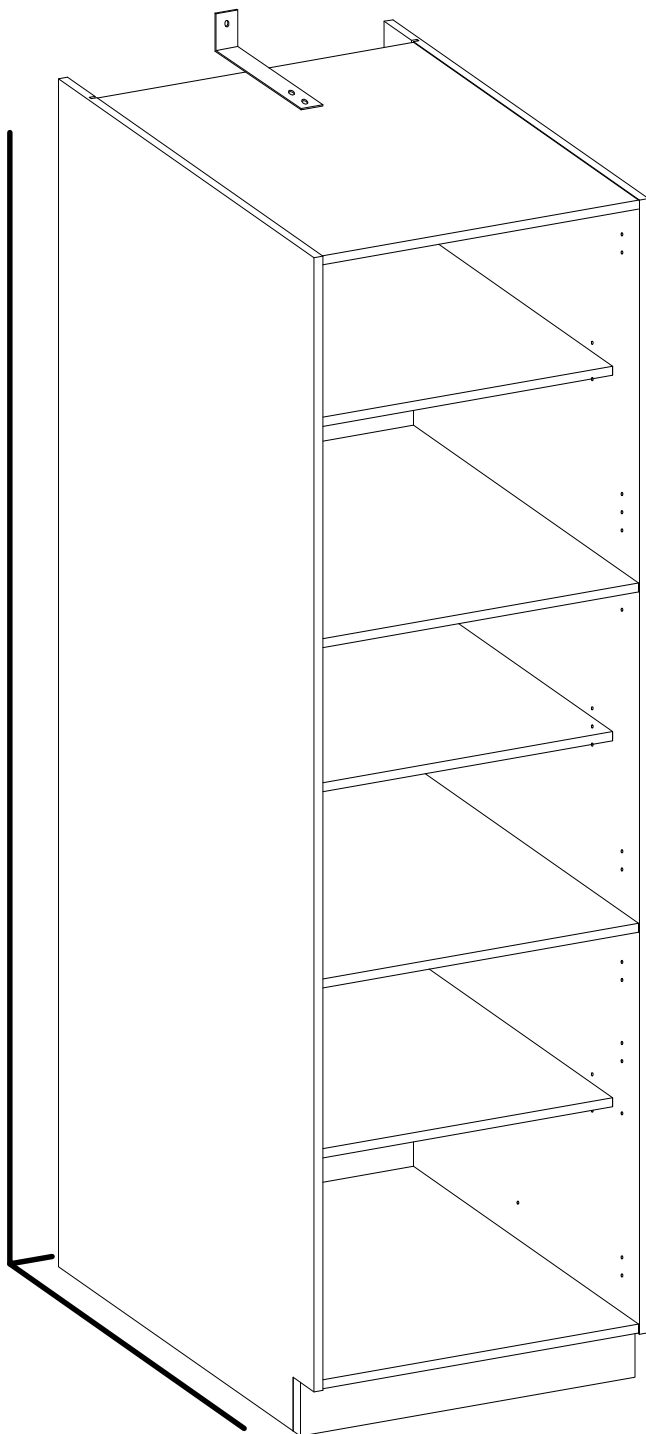
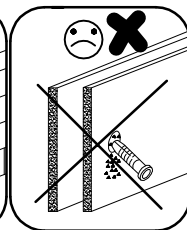
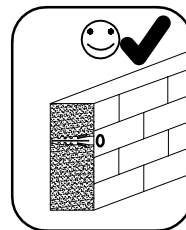
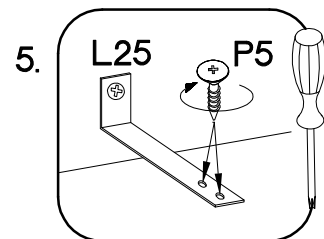
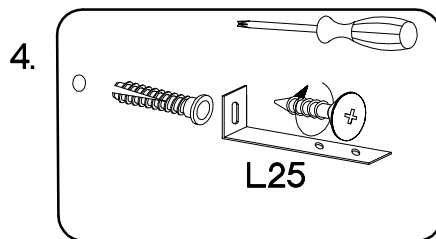
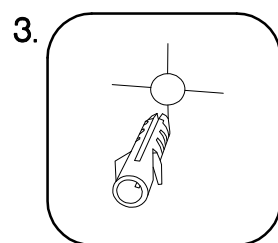
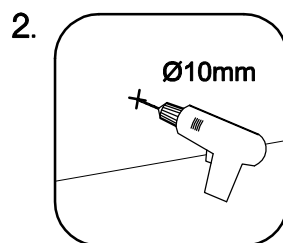
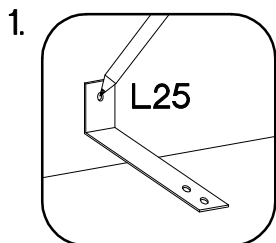

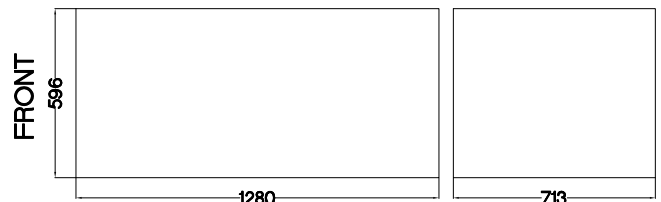
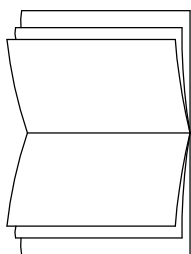

60 DK-2100 2F

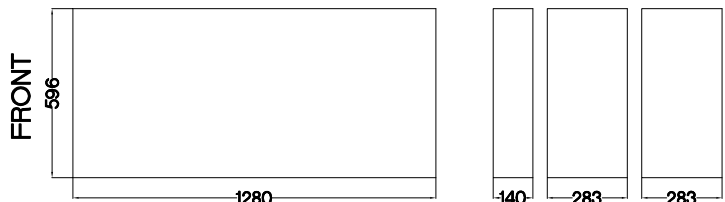
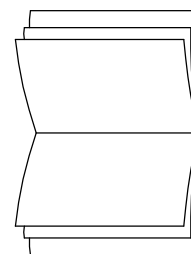
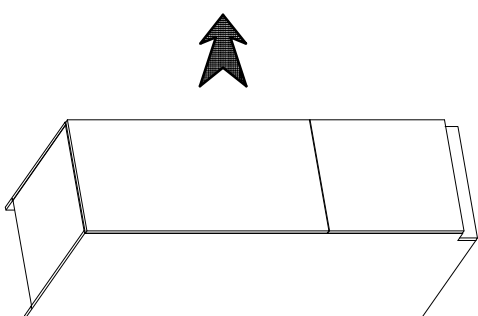

60 DKS-2100 1F 3S

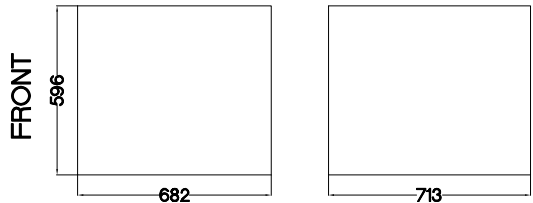
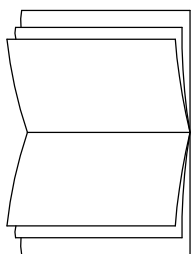
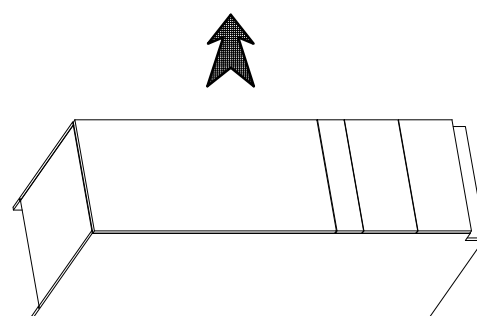

60 DP-2100 2F

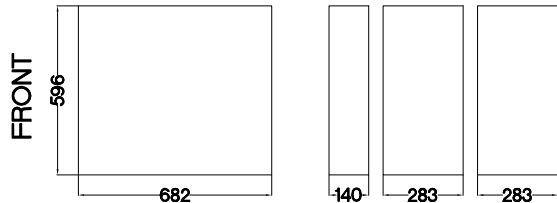
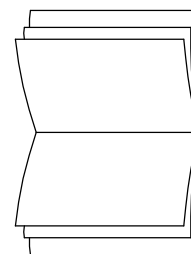
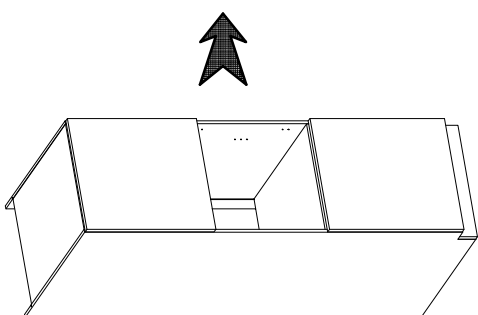

60 DPS-2100 1F 3S

