

SZAFA 2D2S

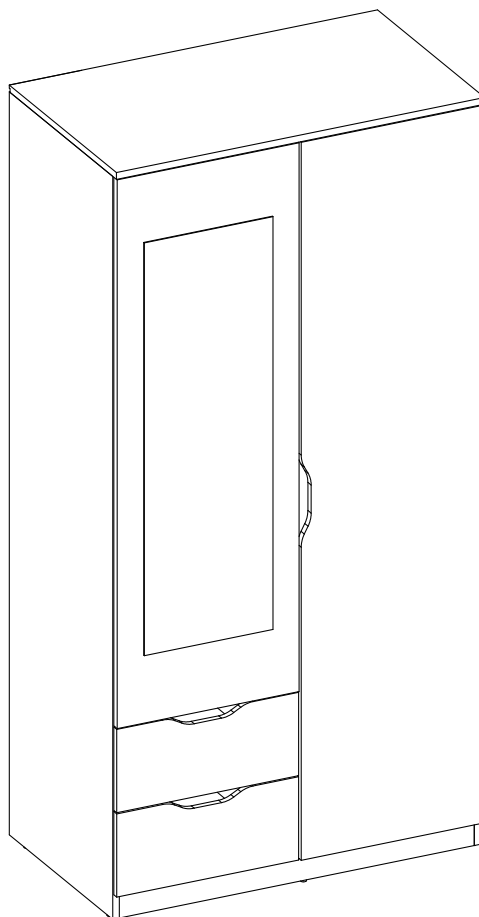

(D) Montageanleitung

(NL) Handleiding voor de montage

(TR) Montaj talimatı

(FR) Instructions de montage

(CZ) Montážní návod

(HU) Összeszerelési útmutató

(GB) Assembly instruction

(PL) Instrukcja montażu

(RU) Инструкция по монтажу

(IT) Istruzioni di montaggio

(RO) Instrucțiuni de asamblare

(SK) Montážny návod



 Achtung • Opgelet • Uwaga • Dikkat • Внимание • Attention Upozornění • Figyelem • Attenzione • Atenție 	
D	Überschreiten Sie angegebenen Maximalbelastungen nicht. Andernfalls kann das Möbelstück beschädigt oder zerstört werden.
GB	Do not exceed the maximum loads specified. Otherwise, the furniture may sustain damage or be irreparably damaged.
NL	Overschrijd de aangegeven maximale belastingen niet. Anders kan het meubelstuk worden beschadigd of vernield.
PL	Nie wolno przekraczać podanych maksymalnych wartości obciążenia. W przeciwnym razie mebel może zostać uszkodzony lub zniszczony.
TR	Belirtilen azami yük değerini aşmayınız, aksi takdirde mobilya parçası zarar görebilir veya kullanılamaz hale gelebilir.
RU	Не допускается превышение указанных максимальных нагрузок. В противном случае возможно повреждение или разрушение мебели.
FR	Ne dépassez pas les charges maximum indiquées. Sinon, le meuble peut être endommagé ou détruit.
CZ	Nepřekračujte uvedená maximální zatížení. V opačném případě může dojít k poškození nebo zničení nábytku.
HU	Tartsa be az engedélyezett maximális terhelhetőséget/teljesítményt. Különben a bútor és annak alkatrészei megsérülhetnek, tönkre mehetnek.
IT	Non superare il carico massimo indicato. Altrimenti il mobile rischia di rovinarsi o frantumarsi.
RO	Nu depășiți solicitările maxime specificate. Altfel puteți să deteriorați sau să distrugeți piesa de mobilier.
SK	Neprekročte uvedené maximálne zaťaženia. V opačnom prípade sa môže nábytok poškodiť alebo zničiť.
D	Die Befestigung des Möbelstückes an der Wand muss von einer fachkundigen Person vorgenommen werden, da für die Montage an die Wand angepasste Dübel erforderlich sind.
GB	A qualified professional is required when mounting furniture to the wall since dowels corresponding to the wall are required for this.
NL	Een vakkundige persoon dient het meubelstuk aan de muur te bevestigen; voor de montage aan de muur zijn immers aangepaste pluggen vereist.
PL	Mocowanie mebla do ściany mogą przeprowadzić wyłącznie wykwalifikowane osoby, z uwagi na zastosowanie odpowiednio dopasowanych kołków do rodzaju ściany.
TR	Mobilya parçasının duvara sabitlenmesi, duvar montajı için özel uyarlanmış dübeller gerektirdiğinden bu iş sadece bu konuda uzman bir kişi tarafından gerçekleştirilmelidir.
RU	Поскольку для монтажа на стене необходимо использовать специальные дюбели, мебель должна быть закреплена на стене квалифицированным персоналом.
FR	La fixation du meuble contre le mur doit être effectuée par une personne compétente car, pour le montage mural, il faut utiliser des chevilles adaptées.
CZ	Montáž nábytku na stěnu musí provést odborník, protože k montáži na stěnu jsou zapotřebí upravené hmoždinky.
HU	A bútorelemek falra rögzítését szakembernek kell végeznie, mert a rögzítéshez megfelelő tiplit kell használni.
IT	Il fissaggio del mobile alla parete deve essere eseguito da persone esperte, dato che occorrono tasselli adeguati.
RO	Fixarea la perete a piesei de mobilier se realizează numai de către personal competent, deoarece montajul de perete necesită dibluri adecvate.
SK	Upevnenie nábytku na stenu musí vykonať odborník, nakoľko sú pre montáž na stenu potrebné vhodné hmoždinky.

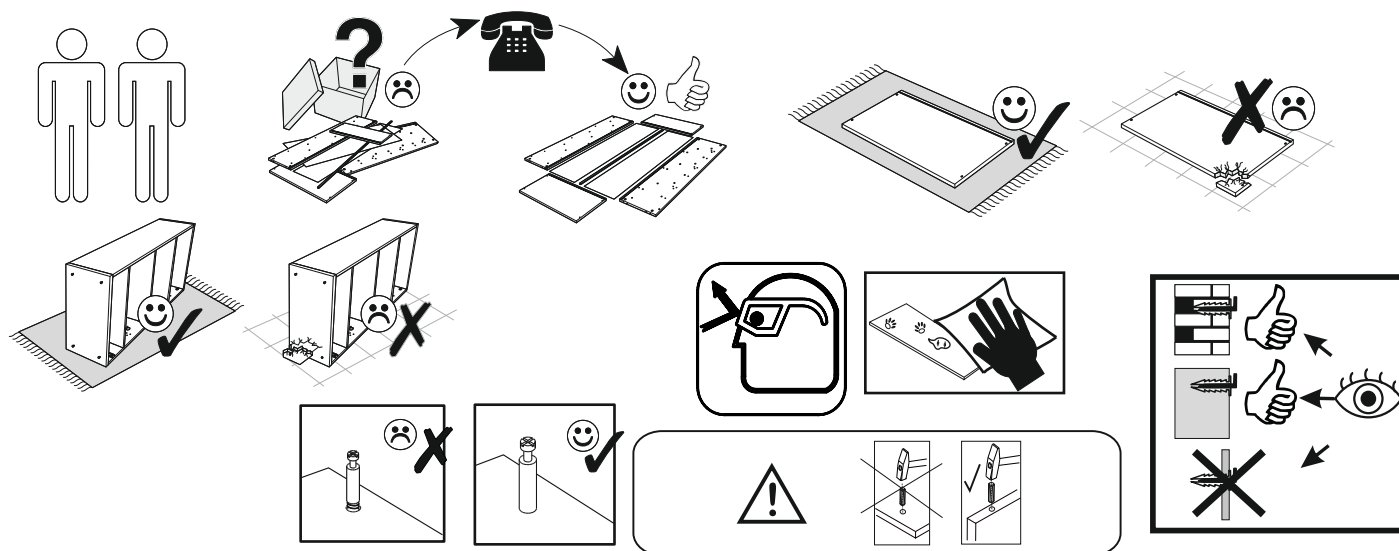

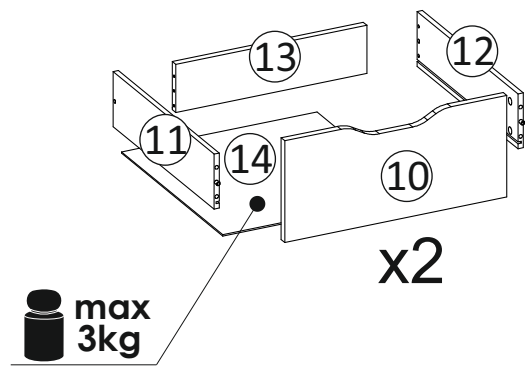
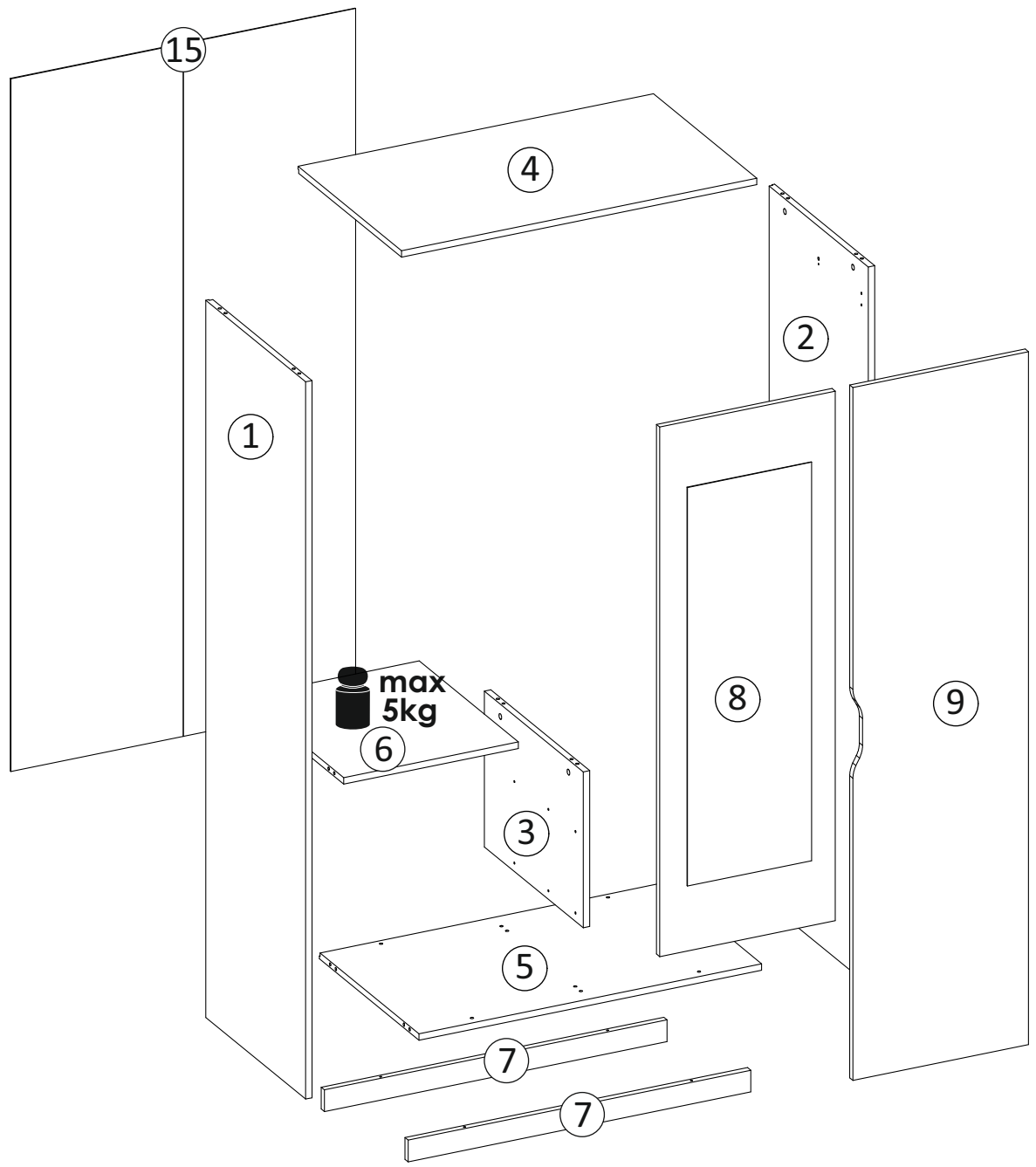

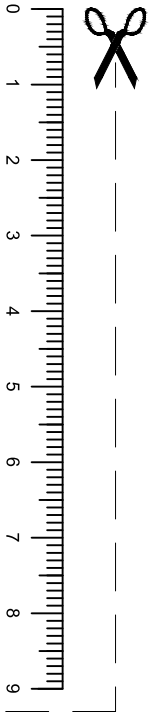

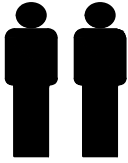
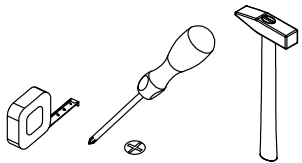





















Sie benötigen: You need: Potrzebne są: Vi servono: Necesita: Necessita: Benodigheden: Potřebujete: Vous avez besoin de: Χρειάζονται τα εξής: Behövs:	Reikalinga: Tarvitset: Nutno mít: Potrebné sú: Szükséges: Du behøver: Trebate: Необходими са: Aveți nevoie de: Необходимы: Potrebni su:		
--	---	--	---

Beschläge / Fittings / Okucia / Raccordi / Herrajes / Ferragens / Beslag / Kovanie / Quincaillerie / Προσαρτήματα επίπλων / Rördelar / Furnitūra / Helat / Kování / Kovania / Vasalatok / Beslag / Oprema / Обков / Fitinguri / Оковки / Okovi

 14 x K2	 8 x K3	 10 x A1	 1 x I	 6 x ZMN
 8 x ZMN1	 2 x ZMN2	 12 x M1	 20 x T2	 6 x Z2
 6 x Z3	 12 x W5	 16 x W1	 2 x F3	 6 x D5
 2 x Z1	 52 x Z4	 2 x R7	 3 x D7	
 12 x W10	 2 x D8	 1 x S2	 8 x M2	

Teile / Article / Części / Accessori / Piezas / Peças / Onderdelen / Diely / Éléments / Εξαρτήματα / Delar / Dalys / Osat / Díly / Časti / Alkatrészek / Dele / Dijelovi / Части / Piese / Части / Delovi

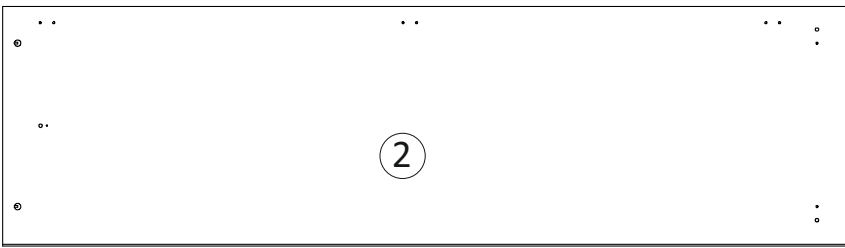
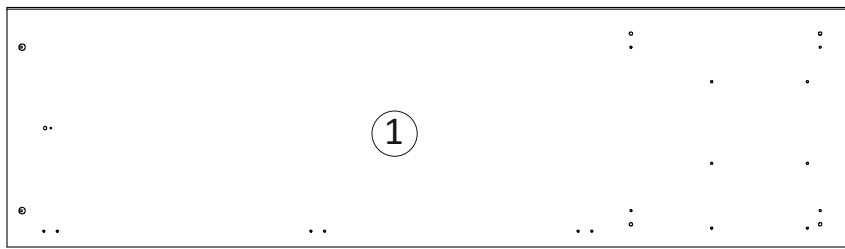

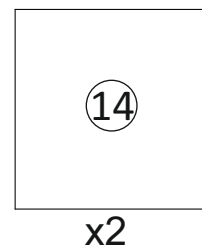
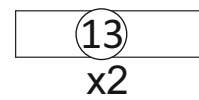
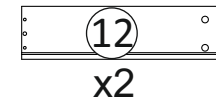
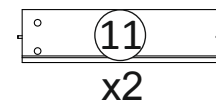
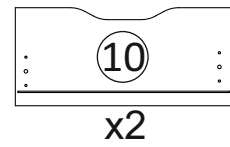
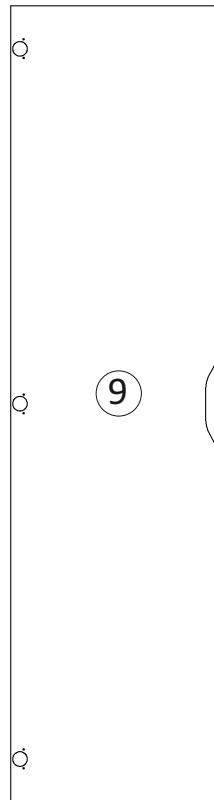
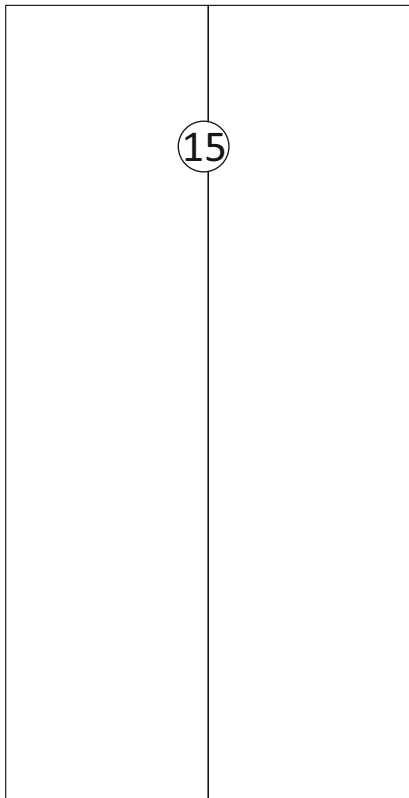
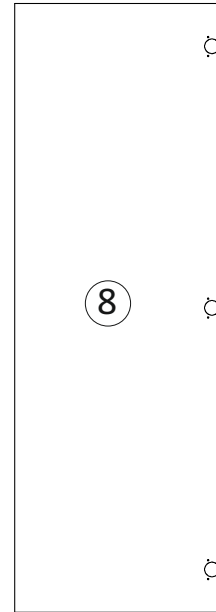
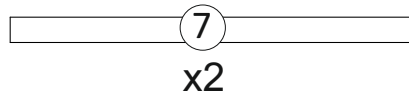
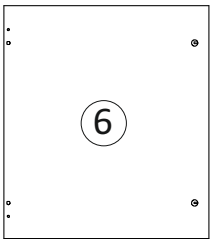
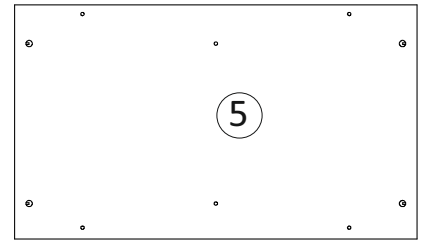
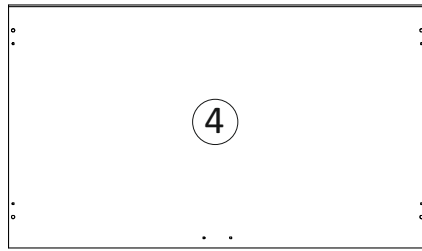
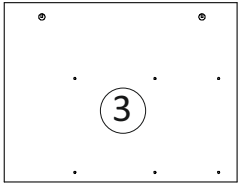

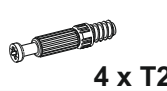

A

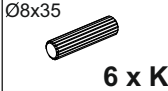
- 

4 x T2
- 

6 x K2
- 

4 x M1
- 

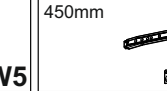
12 x W5
- 

450mm
2 x R7

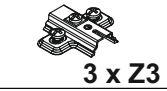
- 

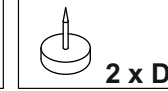
3 x Z3
- 

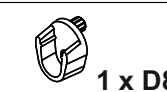
2 x D5
- 

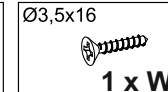
1 x D8
- 

Ø3,5x16
1 x W1

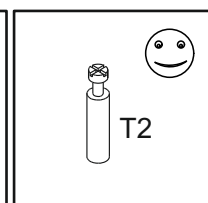
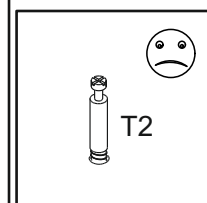
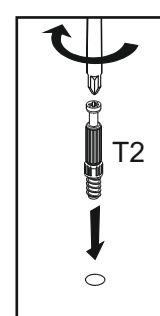
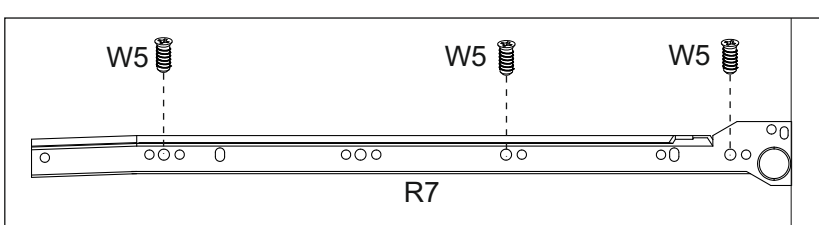
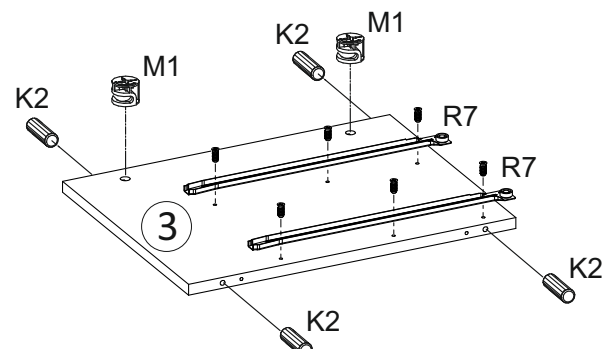
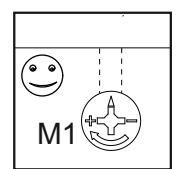
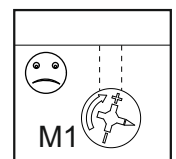
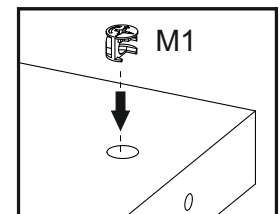
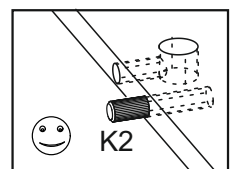
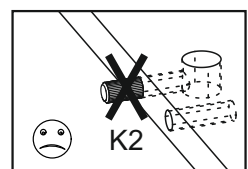
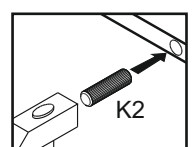
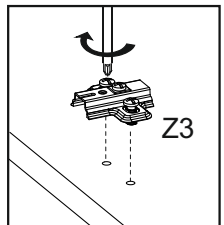
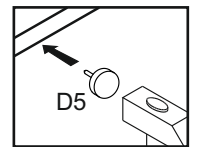
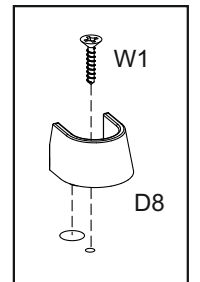
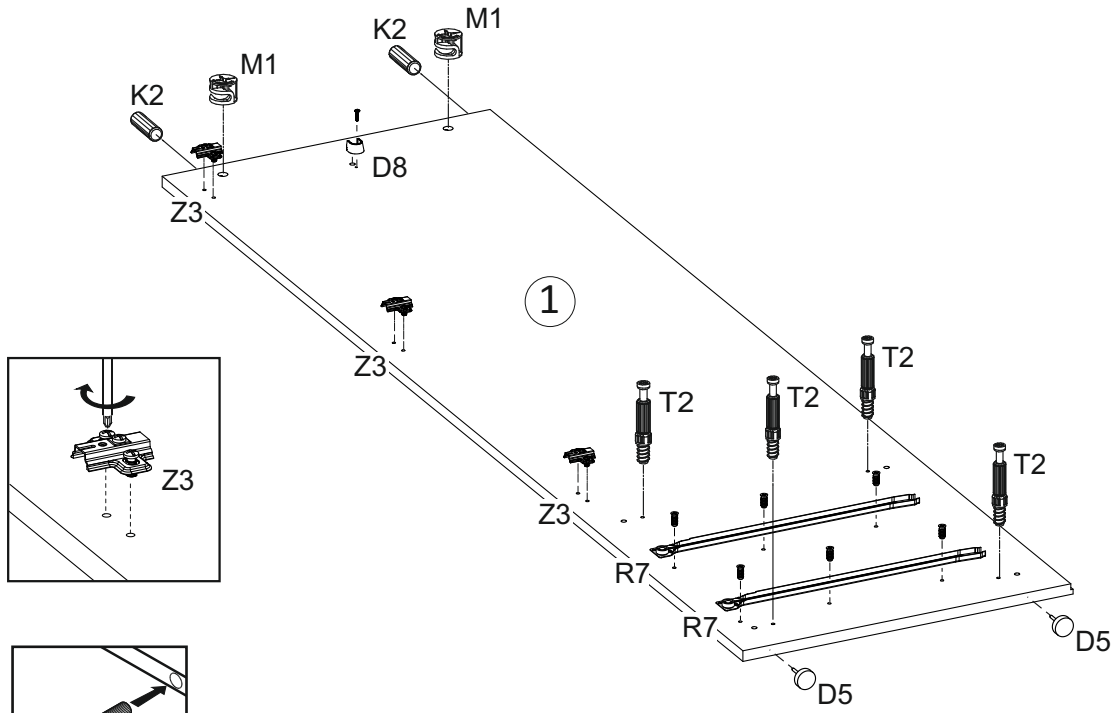
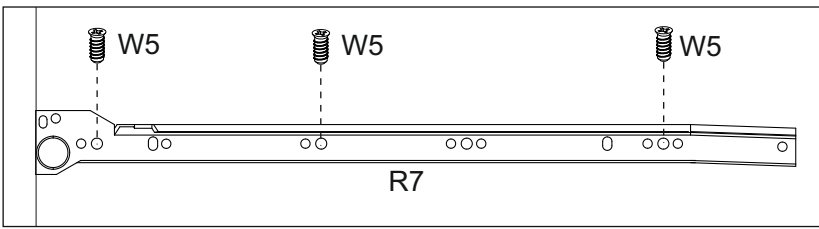

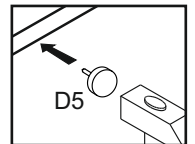
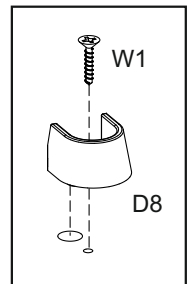
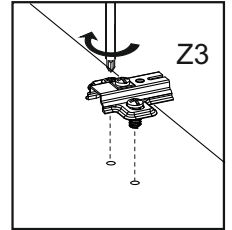
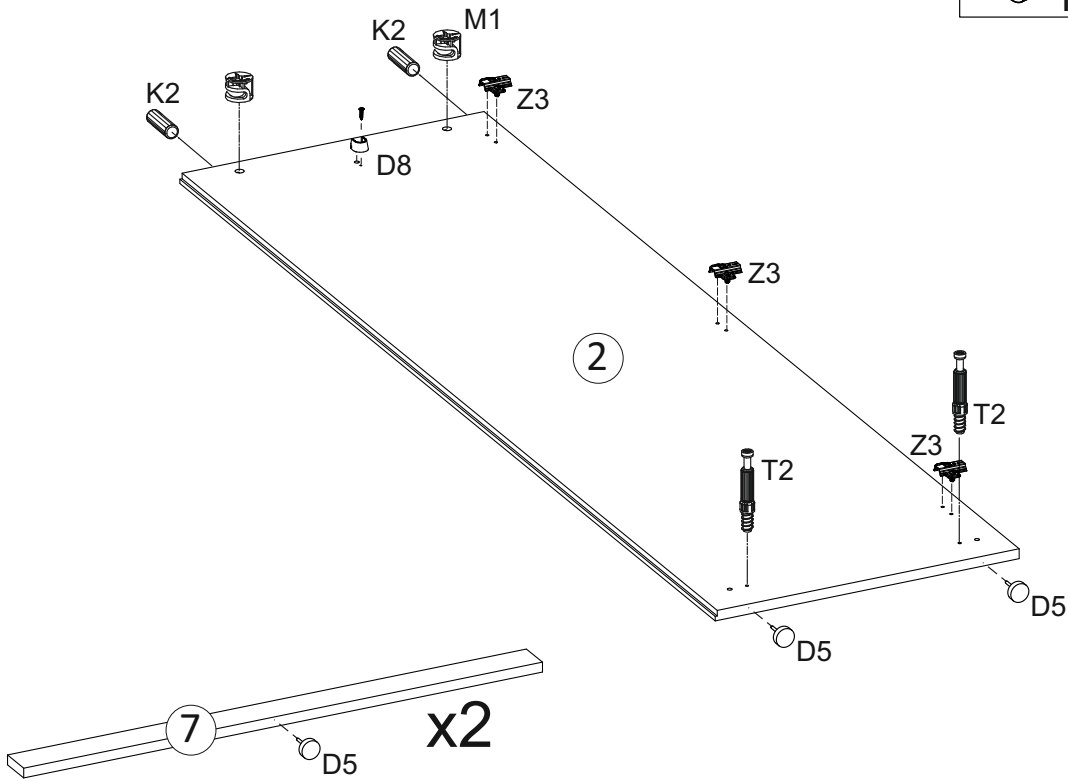
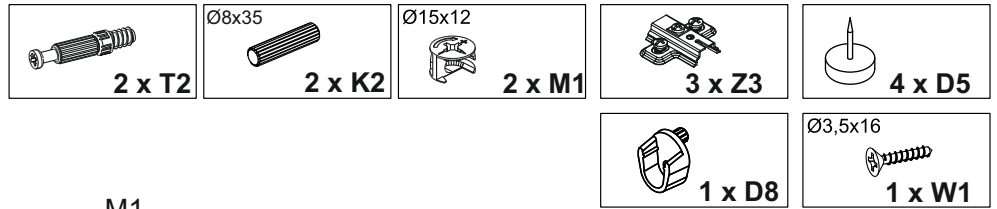
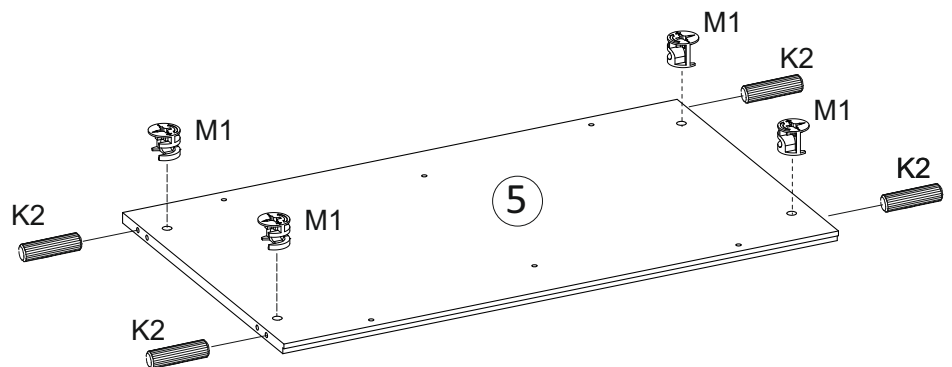
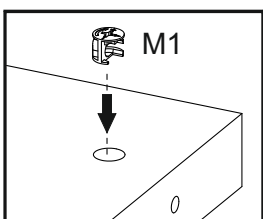
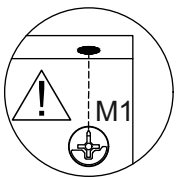
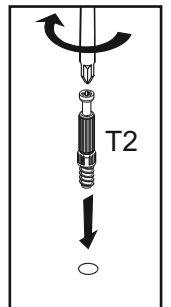
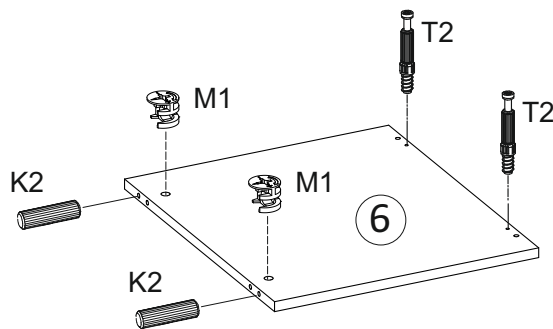
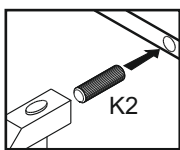
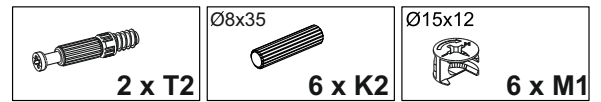
B**C**

D

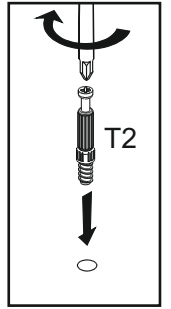
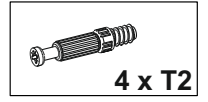
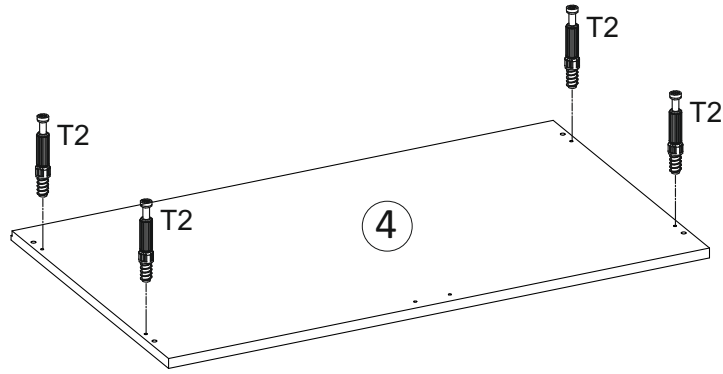

E

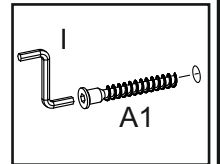
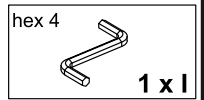
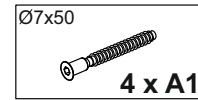
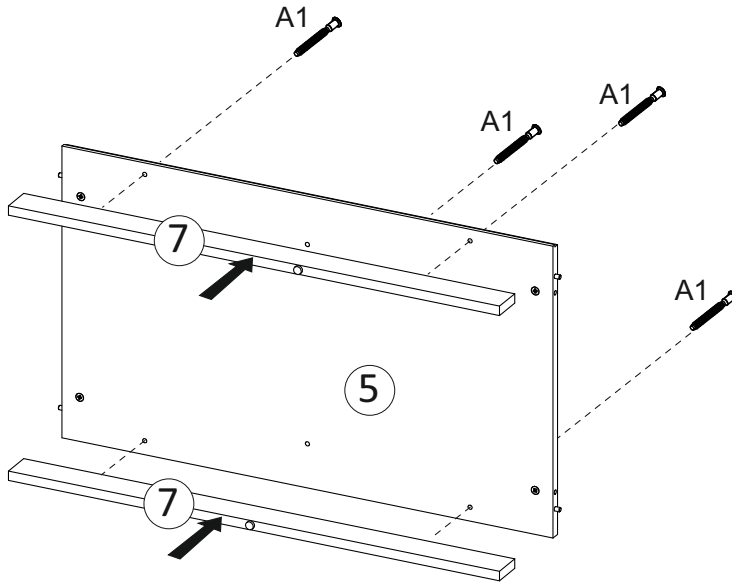

F

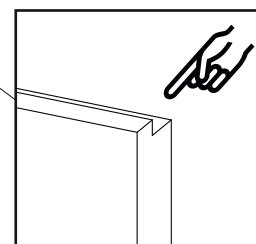
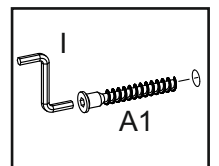
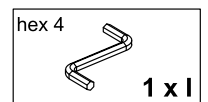
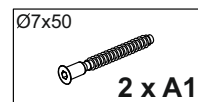
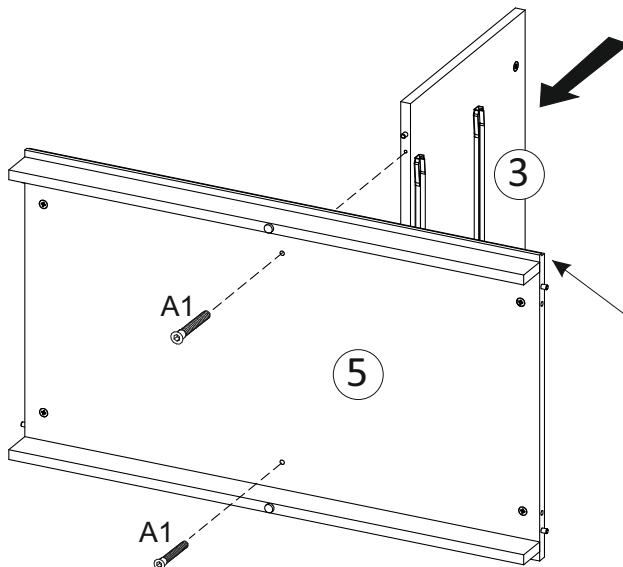

G

Ø15
4 x ZMN

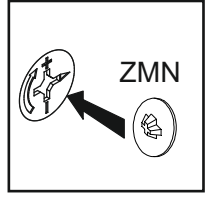
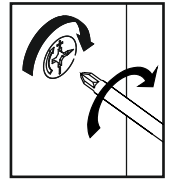
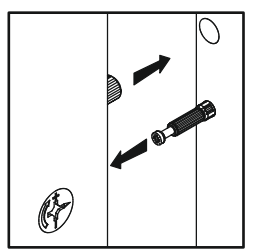
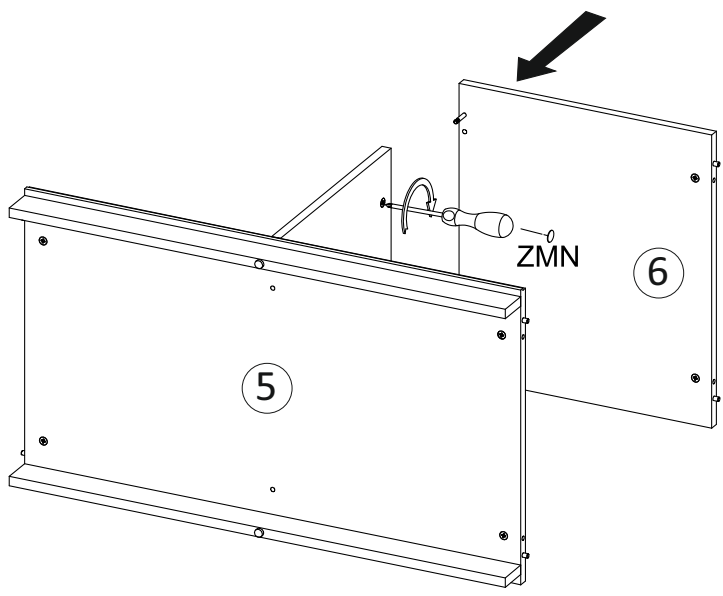

H

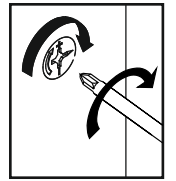
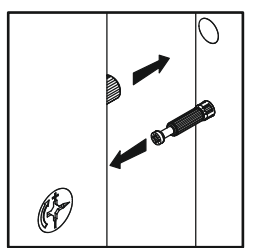
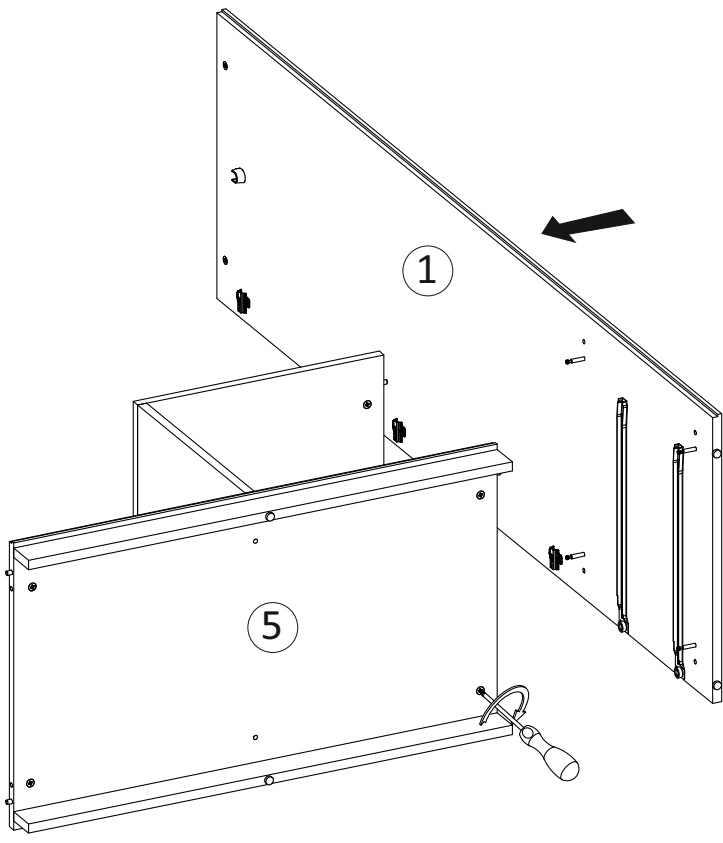

I

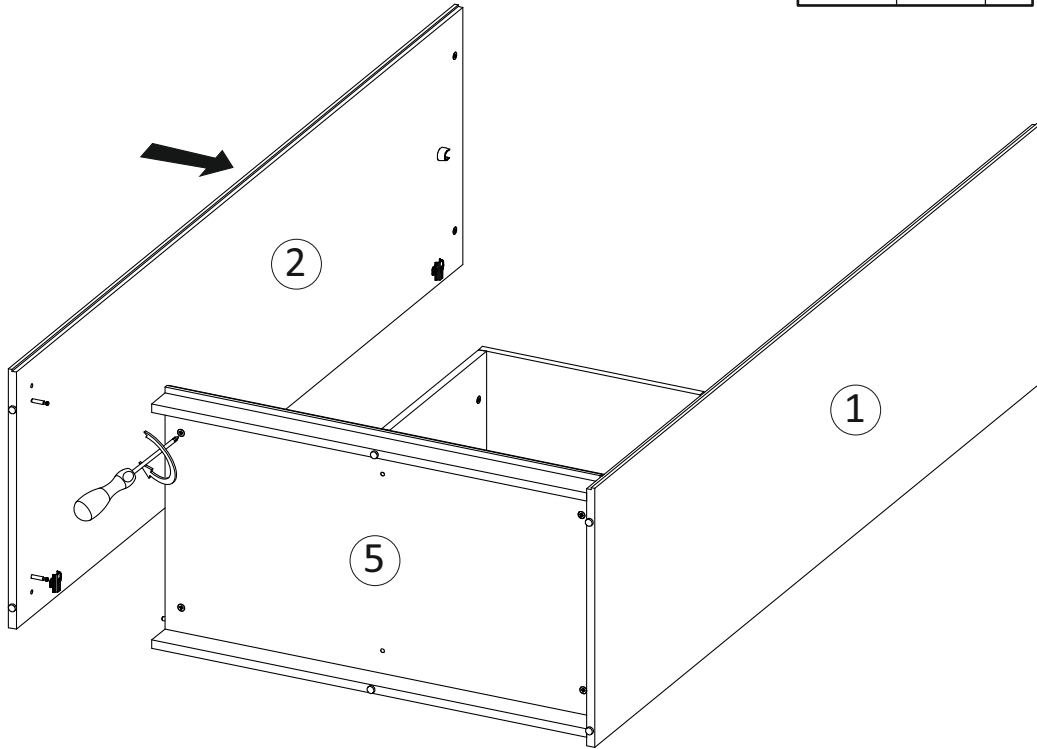
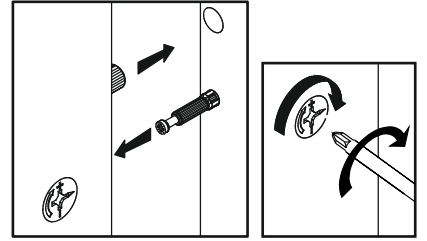

J

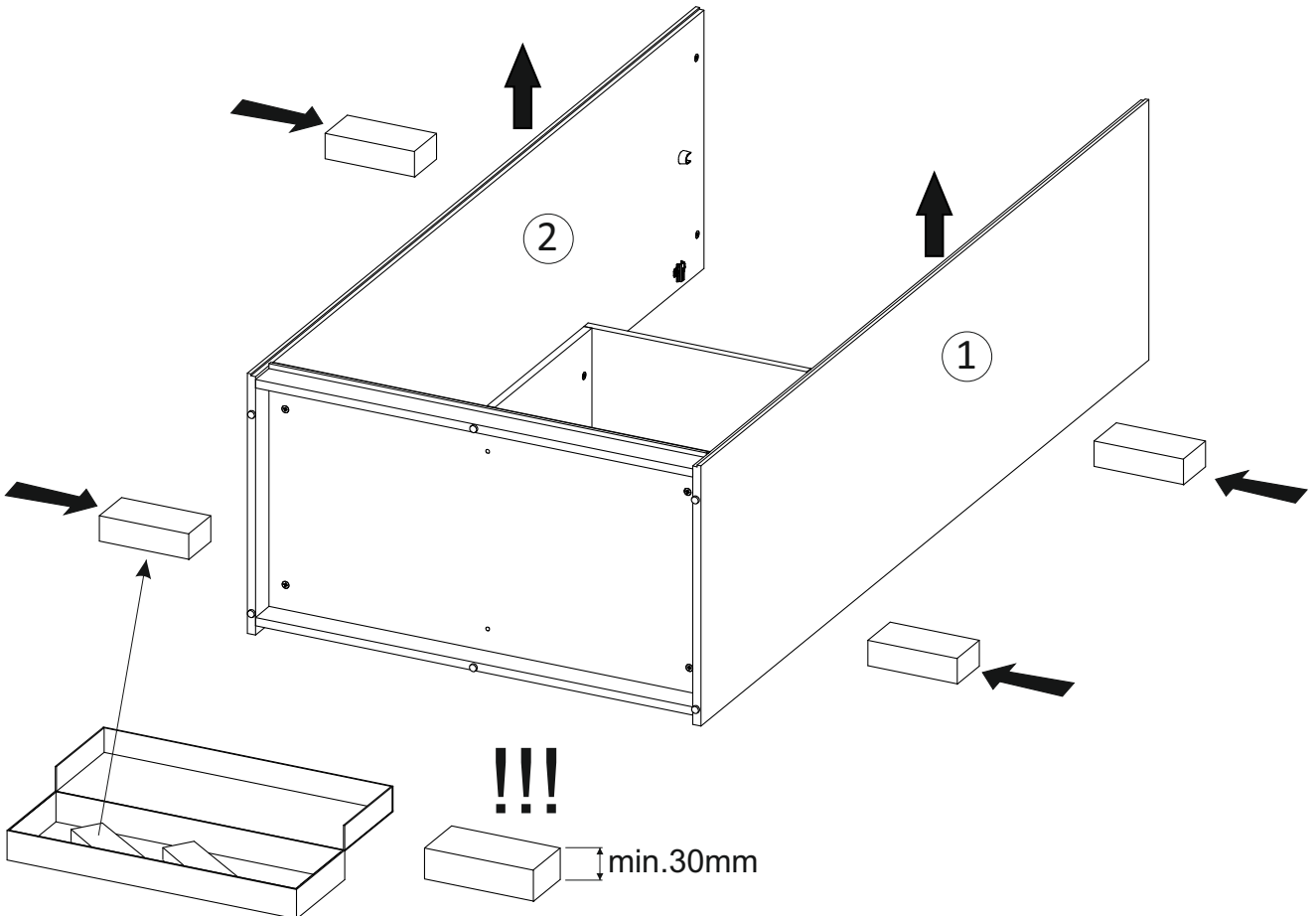

K

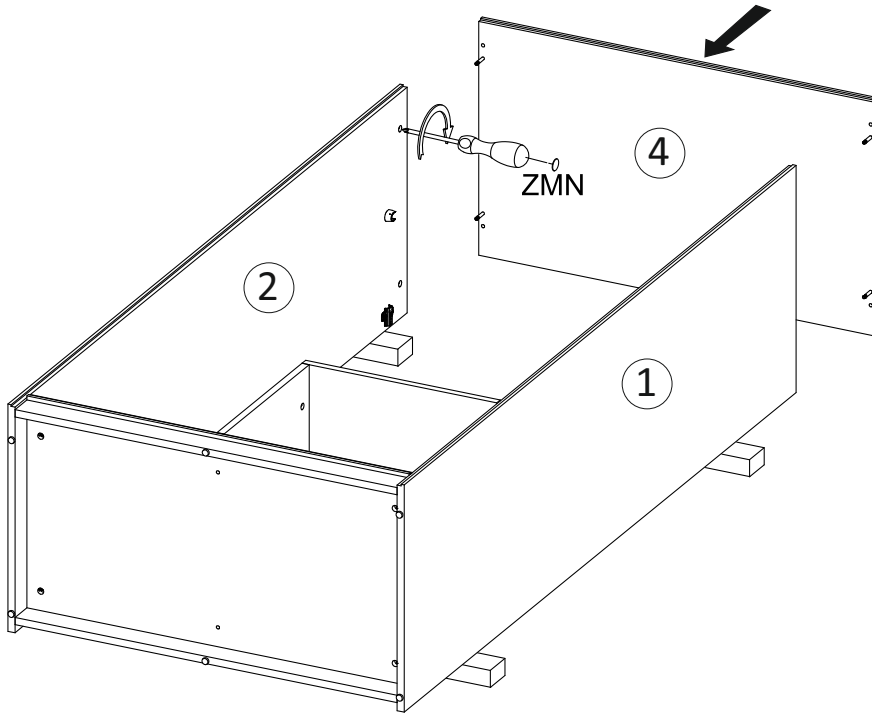

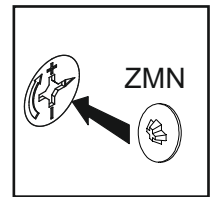
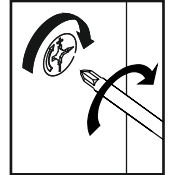
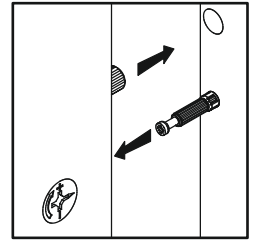

Ø15

 2 x ZMN

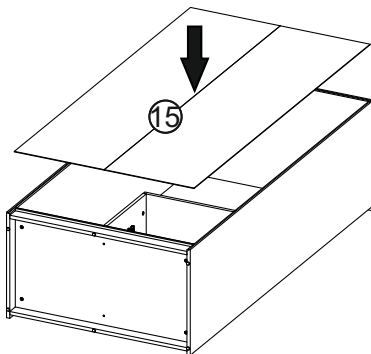

L



 44 x Z4

 3 x D7

A=B

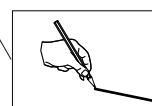
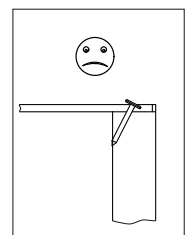
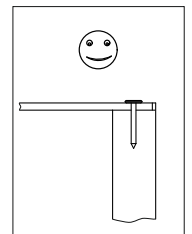
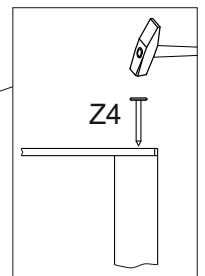
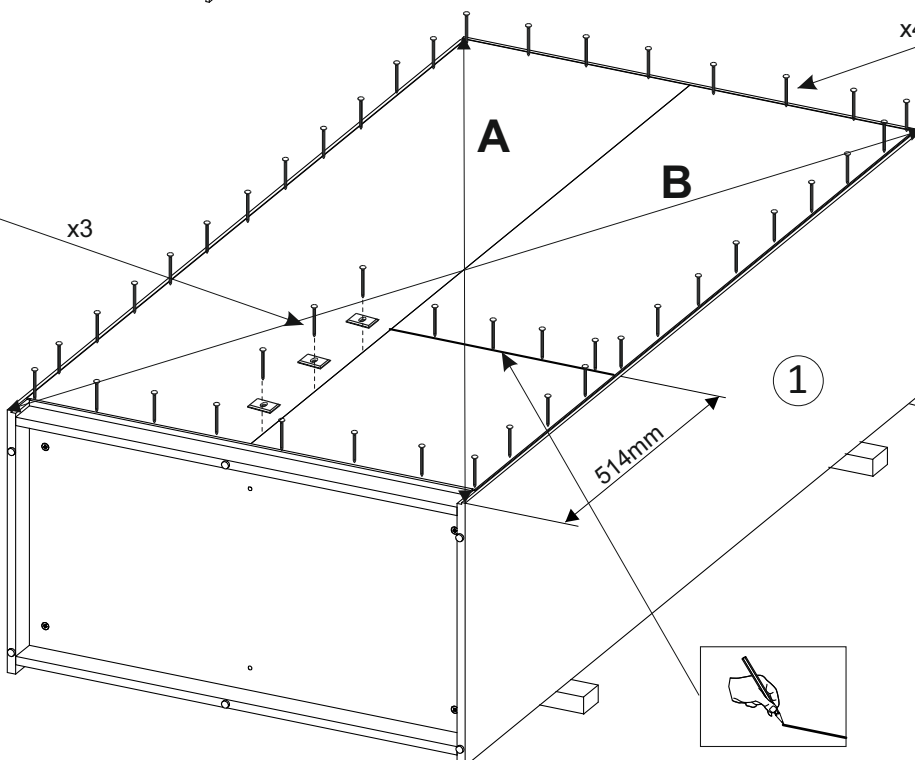
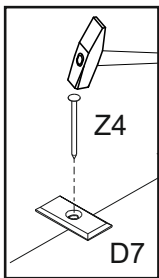

M

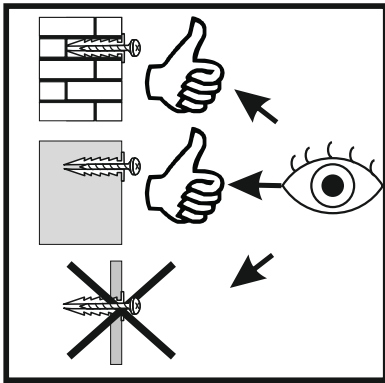
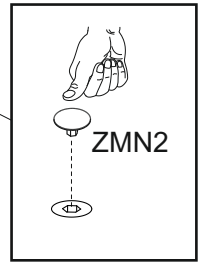
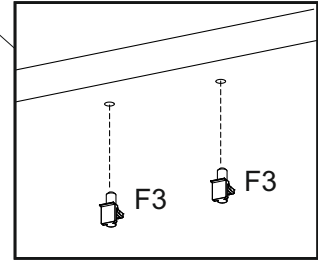
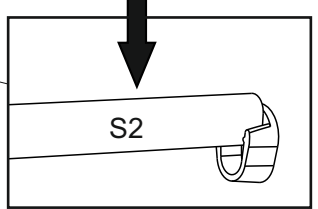
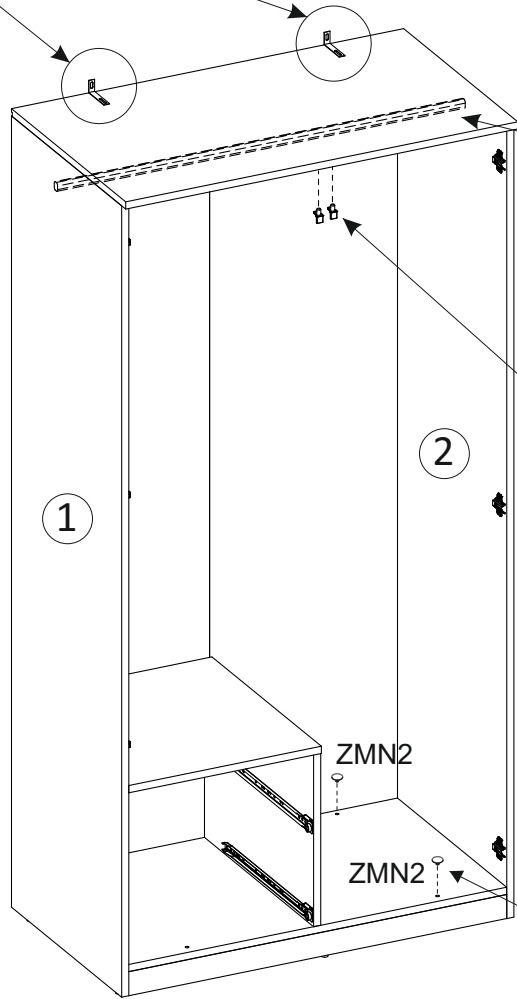
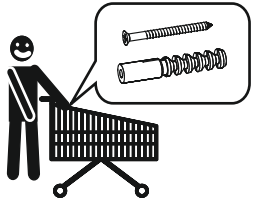
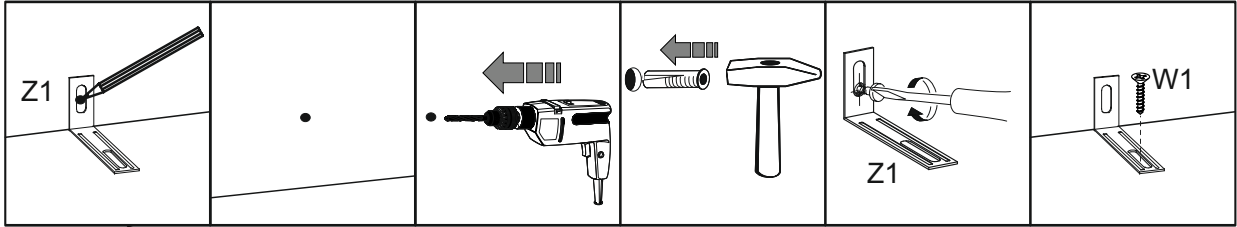
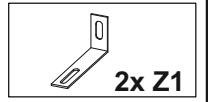
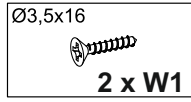
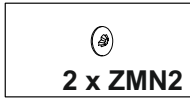
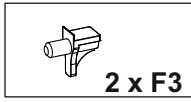

N

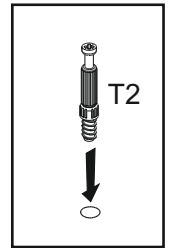
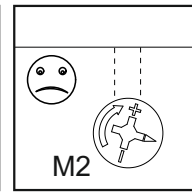
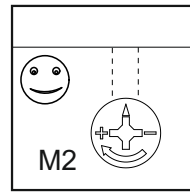
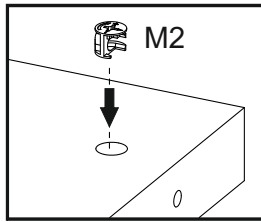
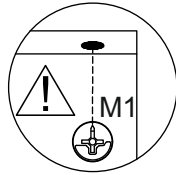
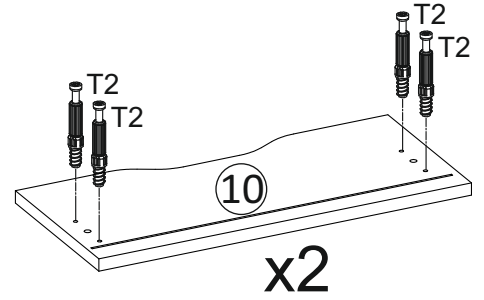
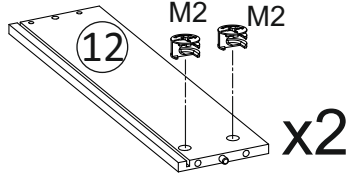
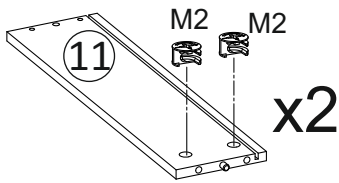
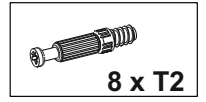
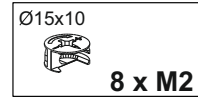
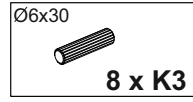
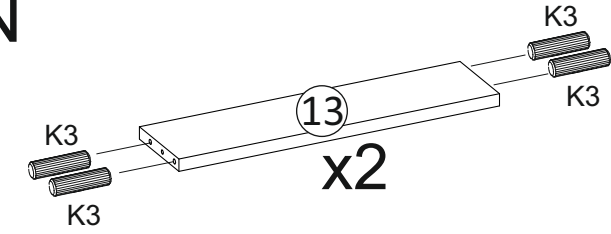

O

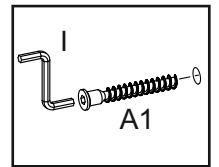
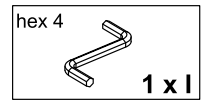
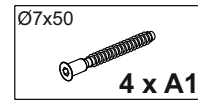
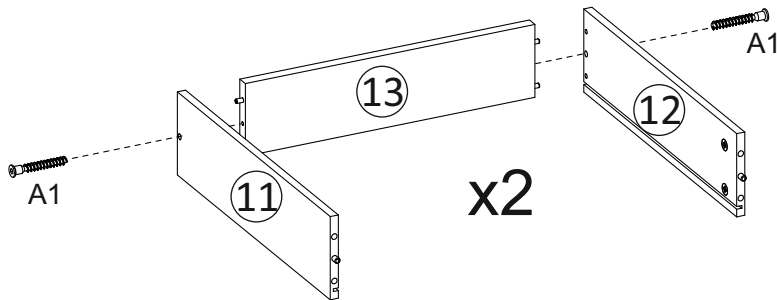

P

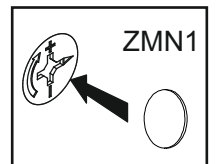
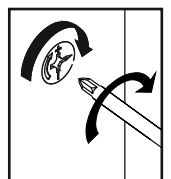
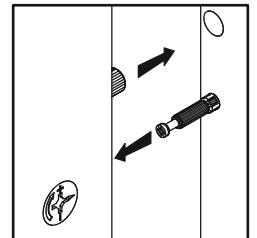
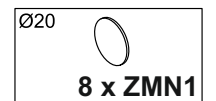
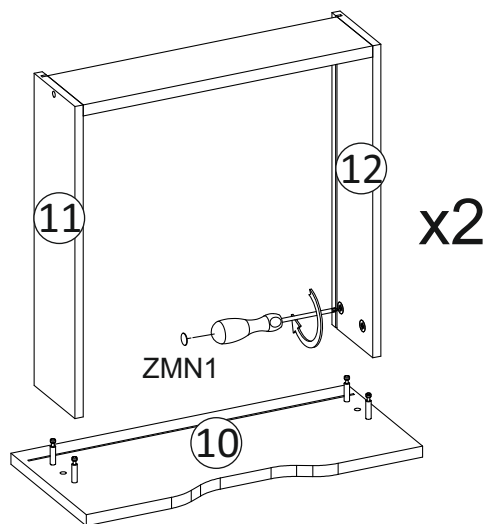

Q

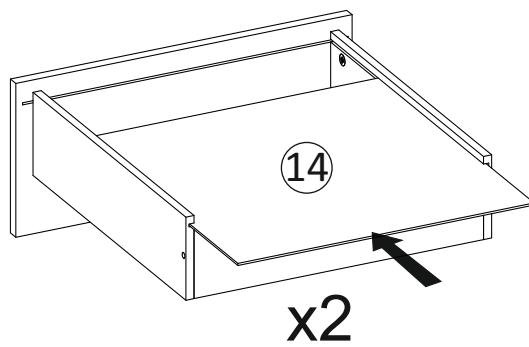

R

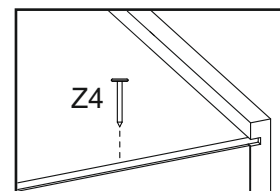
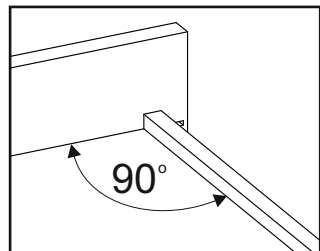
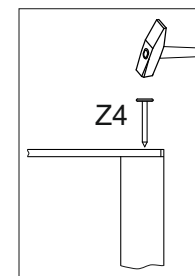
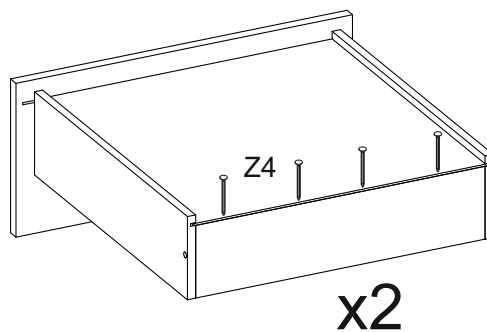
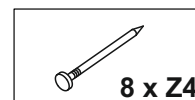
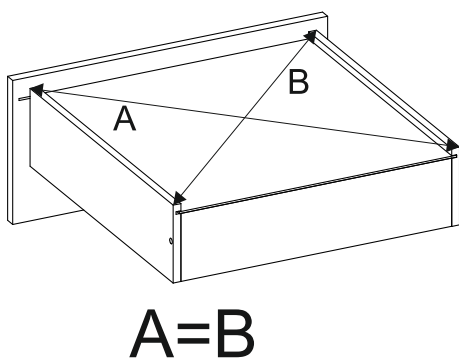

S

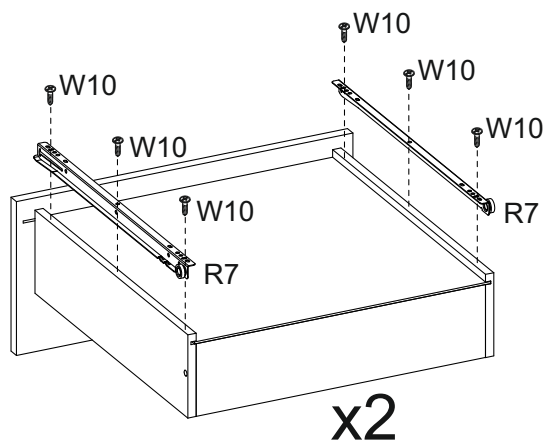
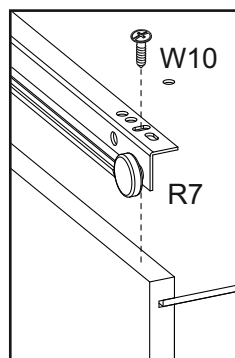
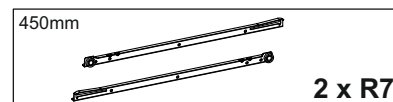
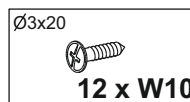

T

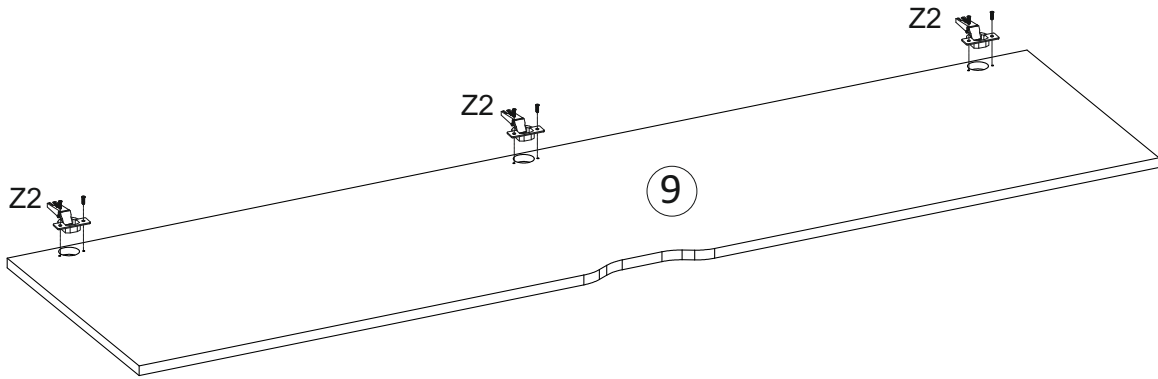
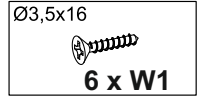
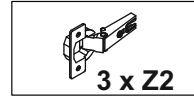
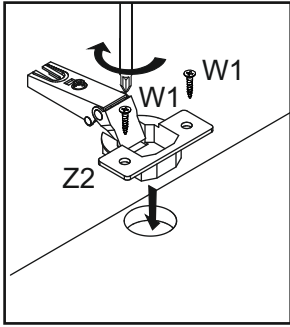

U

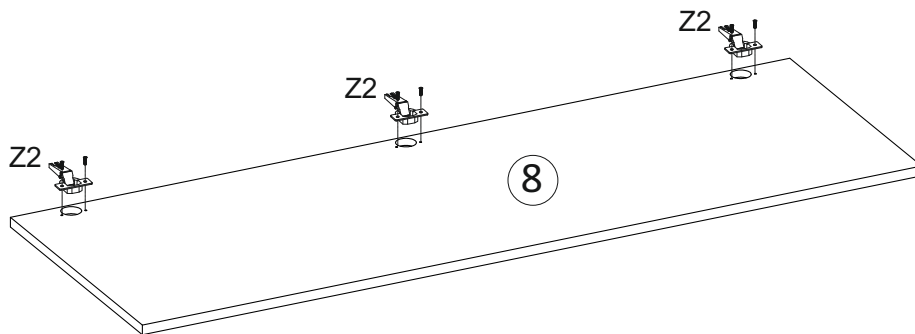
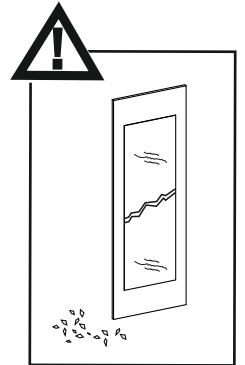
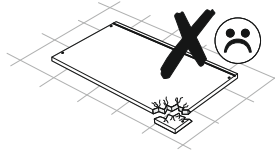
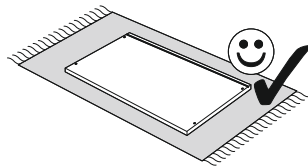
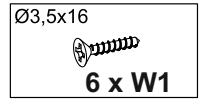
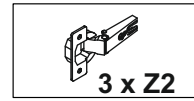
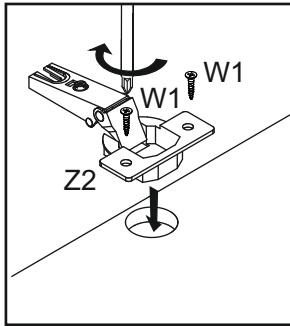

W

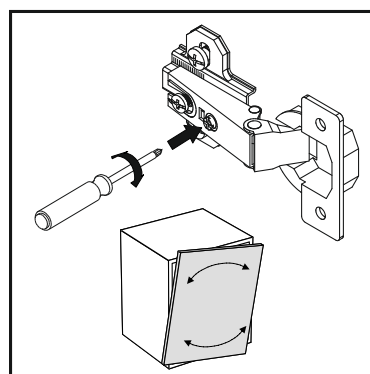
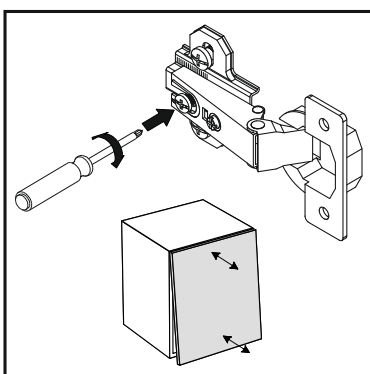
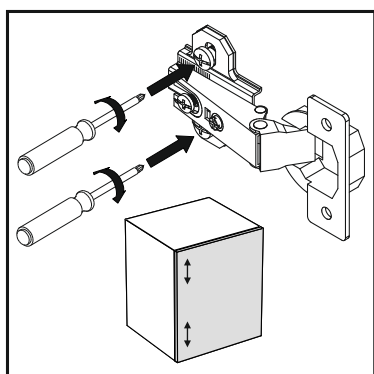
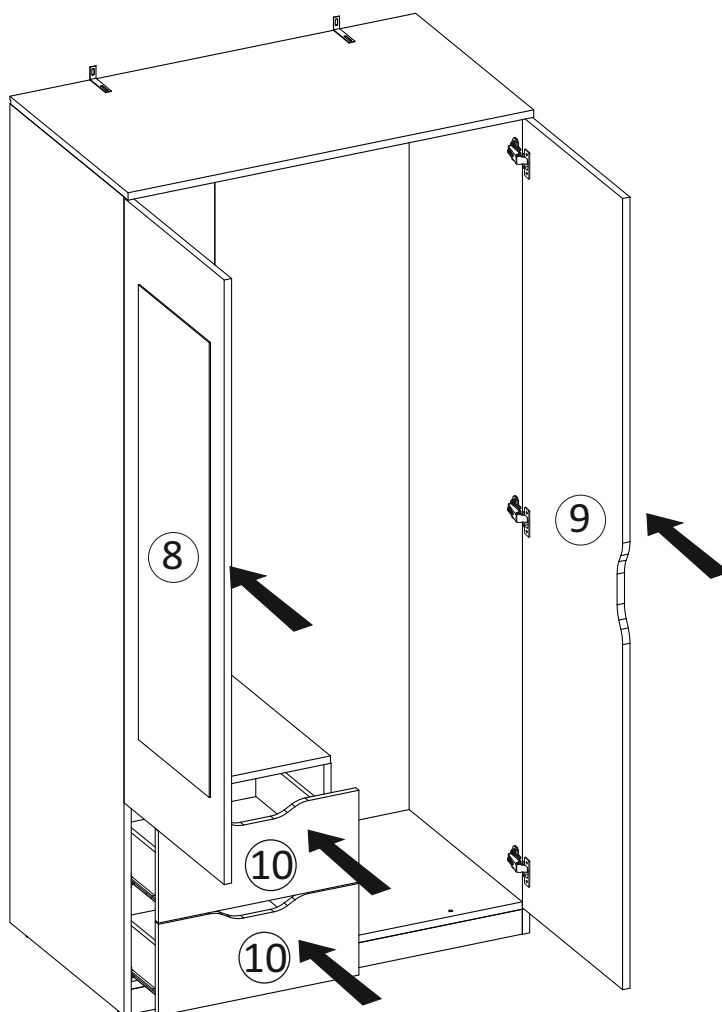
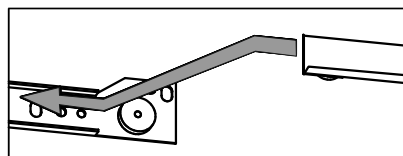
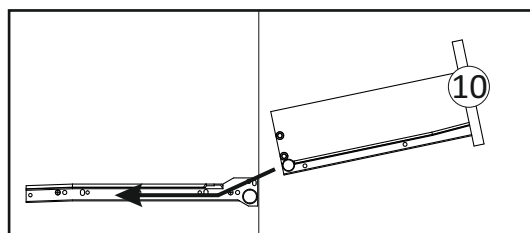
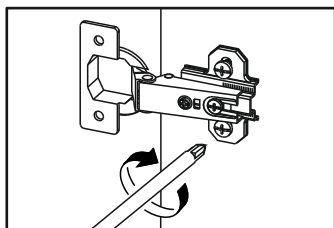
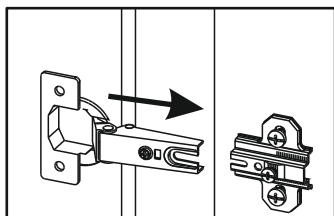

ZASADY BEZPIECZEŃSTWA

1. Przed przystąpieniem do montażu mebla należy zapoznać się całą instrukcją montażu znajdującą się w opakowaniu oraz przestrzegac właściwej kolejności zawartych etapów składania.
2. Należy odpowiednio wybrać miejsce do montażu nie zaleca się montowania mebla na miękkim dywanie. Montaż proszę przeprowadzić na podłodze wyłożonej kartonem pochodzącym z opakowania mebla lub tkaniną np. kocem.
3. Niektóre z modeli mebli wymagają zamocowania do ściany - ze względu na niewystarczającą stateczność własną. Mogą one przewrócić się po otworzeniu drzwi, szuflad, lub wsparciu się czy próbie wspinania się dziecka na półkę. W takich przypadkach należy be zwzględnie zamocować mebel do ściany lub innego stabilnego elementu. Odpowiednie zalecenia są wyraźnie pokazane w instrukcji montażu .
UWAGA!: Do mocowania mebla do ściany standardowo używany jest kołek tworzywowy oraz wkręt, zapewniający właściwe przytwierdzenie tylko w przypadku ścian betonowych najczęściej występujących. W przypadku braku pewności co do rodzaju ściany i pewności zamocowania do niej mebla - a tym samym bezpiecznego jego użytkowania – należy zwrócić się do specjalisty, który określi rodzaj ściany i dobierze do niej właściwy rodzaj kołka.
4. Po ustawieniu na docelowym miejscu użytkowania mebel należy wypoziomować, wykorzystując regulacyjne elementy stopek - nóżek, lub inne : np. podkładki korygujące nierówności podłogi.
5. Podczas przemieszczania mebli należy zachować szczególną ostrożność, dobrać odpowiednią ilość osób w zależności od wielkości i ciężaru mebla. Nie wolno przepychać, przesuwac , ciągnąc mebla gdyż grozi to jego trwałym uszkodzeniem, przewróceniem. W celu przemieszczenia mebla należy go unieść, chwytając za stałe elementy korpusu np. boki , podstawę itp. Nie należy chwytać za ruchome części podczas przemieszczania np. drzwi , szuflady, półki itp..
6. Meble należy użytkować w pomieszczeniach suchych - oraz chronić przed szkodliwymi wpływami atmosferycznymi. Zalecane są normalne warunki klimatyczne: temperatura 15+30 °c w wilgotność względna powietrza 25+80 %/0.
7. W razie stwierdzenia (w czasie użytkowania) poluzowania się połączeń, należy dokonać stosownych korekt: np. regulacji ustawienia drzwi - zgodnie z wytycznymi zawartymi w instrukcji montażu, dokręcenia wkrętów mocujących uchwyty, dociągnięcie złącz mimośrodowych, oraz innych elementów łączących.
8. Ze względu na specyficzne właściwości drewna tworzyw drzewnych oraz powierzchni wykończeniowych, nie należy dopuszczać do trwałych zabrudzeń, do kontaktów np. z olejami, kwasami, innymi substancjami mającymi właściwości żrące, lub oddziaływać ciężkich twardych, ostrych przedmiotów.
9. Do czyszczenia - odkurzania stosować czystą ewentualnie zwilżoną ściereczkę a następnie wycierać do sucha. Części szklane, tworzywowe, metalowe można czyścić dostępnymi w handlu - przeznaczonymi do tego celu środkami chemicznymi, następnie wycierać do sucha i polerować niepalącym miękkim papierem.

UWAGA !!! Nie należy używać środków żrących, szorujących i "nieznanych sprayów".

WICHTIGE HINWEISE , PFLEGE UND GEBRAUCHSANLEITUNG

1. Bitte lesen Sie diese Montageanweisung vor der Montage Ihrer Möbel aufmerksam durch um dementsprechend nach dem Montageschritten zu verfahren.
2. Legen Sie bitte die Möbelteile auf einen weichen Untergrund (dazu können Sie den Verpackungskarton oder ein Gewebe wie z.Bne Decke verwenden.
3. Das beiliegende Montagematerial (Schrauben und Wanddübel) ist nur für Massivwände geeignet. Informieren Sie sich vor der Wandmontage über das geeignete Montagematerial für Ihre Wand.
4. Nach Veränderungen des Montagezustands besteht dieSorgfaltspflicht zur Nachjustierung.
5. Nach Aufbau nur vorsichtig verschieben (engagieren Sie bitte dazu entsprechende Personenanzahl), anderenfalls können Ihre Möbel beschädigt werden.
6. Ein ideales Raumklima besteht bei einer Temperatur von 15÷30 °C sowieiner Luftfeuchtigkeit von 25÷80 %.
7. Die Beschlagtechnik der Scharnier, Führungs-, Schließ-, Selbsteinzugssysteme ist wartungsfrei. Nach Veränderungen des Montagezustands besteht aber die Sorgfaltspflicht zur Nachjustierung.
8. Grundsätzlich sollen alle Verschmutzungen und Flüssigkeiten wie Öl, Säure u. ä sofort gereinigt werden. Vermeiden Sie bitte Spülmittel und Gegenstände, die Oberfläche beschädigen könnten.
9. Wir empfehlen Ihnen die Oberfläche nur mit einem weichen Staubtuch oder einem leicht feuchtem Tuch zu reinigen. Verwenden Sie außerdem keine Möbelpflegemittel oder Scheuermittel, die die Oberfläche angreifen könnten.

ACHTUNG!!! Vermeiden Sie Spülmittel mit bleichenden Zusätzen, Scheuermittel oder „unbekannte Sprays“.

A BÚTOROK BIZTONSÁGOS HASZNÁLATÁVAL, KARBANTARTÁSÁVAL, ÁPOLÁSÁVAL KAPCSOLATOS TUDNIVALÓK

1. A bútor összeszerelését megelőzően fontos, hogy megismerjük teljes terjedelmében a csomagolásban található összeszerelési útmutatót, és hogy betartsuk az útmutató szerinti összeállítási sorrendet.
2. Válasszunk megfelelő helyet az összeszereléshez – nem ajánlatos a szerelést puha szőnyegen végezni. A szerelést javasoljuk a padlón végezni, melyet a munka megkezdése előtt takarjunk le csomagolásból származó papírral, vagy textíliával (pl. pokróccal).
3. Néhány bútor modell esetében – melyek stabilitása nem kielégítő – szükséges a bútor falhoz való rögzítése, melynek hiányában azok előre dőlhetnek az ajtók, fiókok kinyitása, vagy a bútorra támaszkodás következtében, vagy a gyerekek polcokra történő felmászása esetén. Ilyen bútorokat feltétlen hozzá kell a falhoz, vagy más stabil ponthoz rögzíteni. A rögzítés módját az összeállítási útmutató egyértelműen szemlélteti.
FIGYELEM! A bútor falhoz való rögzítése alap esetben - az általában előforduló beton falak esetében - műanyag dűbel és pozdorja csavar segítségével történik. Ha nem lennénk biztosak a fal jellegét illetően, a bútor biztonságos használata érdekében forduljunk szakemberhez, aki meghatározza a fal jellegét, és kiválasztja a rögzítéshez megfelelő dűbel fajtáját.
4. A rendeltetési helyére történő beállítását követően végezzük el a bútor szintbe állítását. A szintbe állítást végezhetjük a szabályozható magasságú bútor lábakkal, vagy alátétek segítségével, melyek kiegyenlítik a padlózat egyenetlenségeit.
5. A bútor áthelyezése alkalmával járjunk el fokozott elővigyázatossággal; a bútor mérete és súlya alapján válasszunk a feladathoz megfelelő számú embert. A bútort ne húzzuk, vagy ne toljuk az áthelyezés során, mivel ez a bútor tartós meghibásodását, esetleg felborulását eredményezi. Az áthelyezés alkalmával a bútort meg kell emelni a bútortest stabil pontjainál fogva – ilyen részei a bútoroknak az oldalak, az alj, a lábazat stb. Áthelyezéskor ne emeljük a bútort a mozgó elemeknél – mint ajtók, fiókok, polcok – fogva.
6. A bútorokat száraz helyiségekben használjuk, és védjük őket a káros környezeti hatásoktól. A szokásos és egyben javasolt klimatikus körülmények: 15 ÷ 30 °C hőmérséklet, és 25÷80% relatív páratartalom.
7. Ha a bútorok használata során a csatlakozások fellazulását észleljük, korrigáljuk azokat jellegük szerint : pl. állítsuk be újra az ajtókat az összeszerelési útmutatóban foglaltak szerint, csavarjuk be a fogantyúk meglazult csavarjait, húzzuk meg az excenter kapcsolatok csatlakozásait, vagy más összekötést szolgáló elemeket.
8. Tekintettel a faanyagok, a takaró felületek sajátos tulajdonságaira, ne hagyjuk hogy a bútor tartósan szennyeződjön, maró hatású anyagokkal olajokkal, savakkal érintkezzen, vagy nehéz, kemény, éles tárgyak fejtessenek ki hatást rájuk.
9. A bútorok tisztításához, a por eltávolításához használjunk tiszta, szükség esetén nedvesített törölkendőt, majd töröljük a bútort szárazra. Az üveg, a műanyag és a fém alkatrészek tisztításához használhatjuk a kereskedelemben kapható, e célra szolgáló vegyszereket, majd töröljük az elemeket szárazra, és polírozzuk át puha, rostot nem kibocsátó papírral.

FIGYELEM !!! Ne használjunk a bútorok tisztításához maró, vagy súroló hatású szereket, ill. "ismeretlen aerosol permeteket".

SAFETY AND CRE ADVISE

1. Please read the entire manual carefully before starting assembly and/or using this product. Follow the manual thoroughly and keep it for the further reference.
2. In order to avoid straching this furniture should be assembled on a soft level surface to avoid demaging the unit – this could be for example a rug or a carton.
3. Some furniture should be fixed to the wall as they might be not stable enough. In those cases you should use the suitable fittings.
ATTENTION!!! Make sure that the screws and wall fittings are suitable for supporting your unit. If you have any doubts about the correct wall fittings for you wall, seek professional advise.
4. The furniture is only guaranteed to work properly if it is adjusted correctly by using adjustable feet or other suitable correcting pads.
5. When moving furniture keep extra safety – depend on furniture weight use the suitable number of people. Lift them with care – do not hold them on moving parts like: shelves, drawers etc. Please do not push or pull the furniture – this can damage the goods.
6. Furniture should be placed in drought places, recommended condition are: temprature 15÷30°C in humidity 25÷80%.
7. It is important that any product which is assembled using any kind of screw is re-tightened 2 weeks after assembly – in ordert o assure stability through-out the lifespan oft the product.
8. Due to specific properties of wood – it is not allowed to cover surfaces with pernament dirt or stay in touch of any chemical, aggressive substances.
9. General cleaning instruction – wipe clean with a damp cloth. Use only water or a gentle detergent. Wipe dry with a clean cloth or non flammable paper.

ATTENTION!!! Do not use aggressive cleaners and additives.