

a1 8x35 x...(x13)	a2 8x45 x...(x1)	b11 x...(x7)	c1 Euro 4x13 x...(x14)	d2 x...(x6)	e0 x...(x13)	e1 x...(x13)	f1 x...(x11)	f8 x...(x1)	g0 x...(x5)
g1 7x50 x...(x5)	i2 4x16 x...(x14)	i10 3,5x22 x...(x4)	m x...(x1)	n1 3x16 x...(x10)	o15 x...(x4)	q9 x...(x2)	r3 x...(x12)	r4 x...(x14)	

1

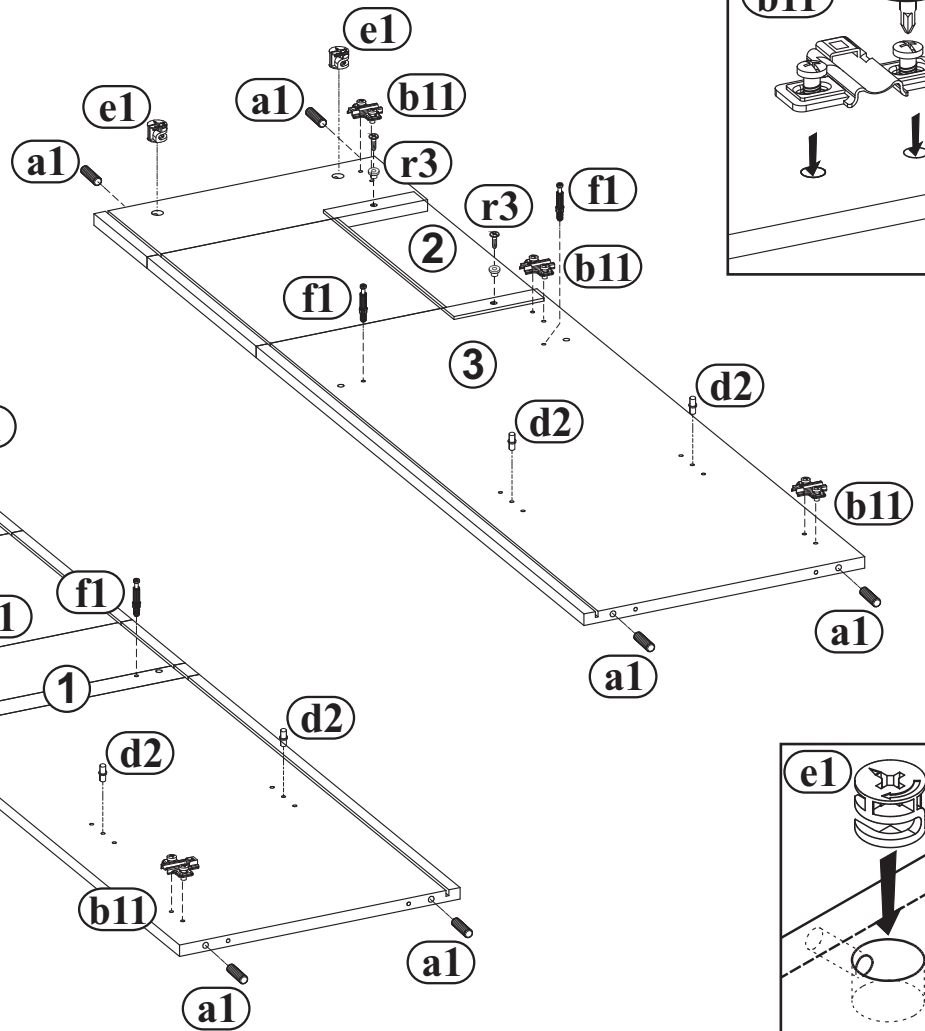

2

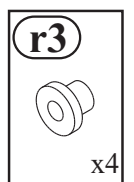
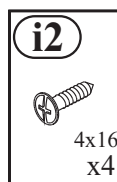
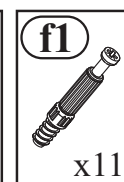
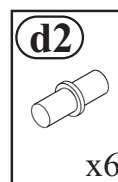
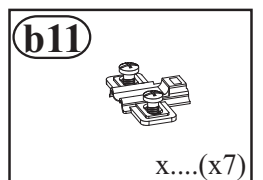
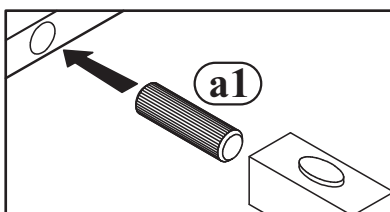
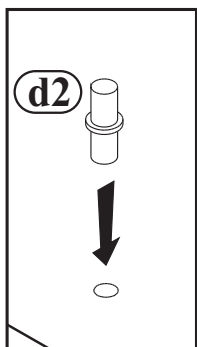
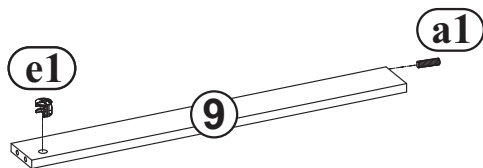
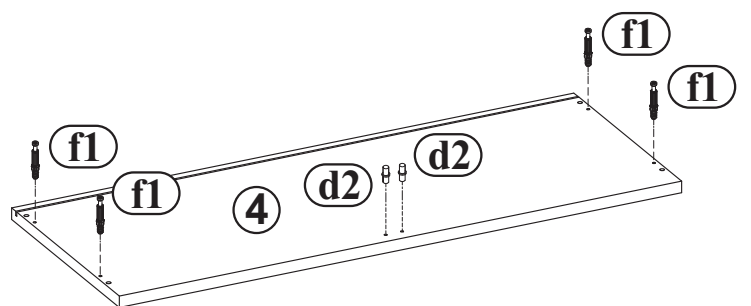
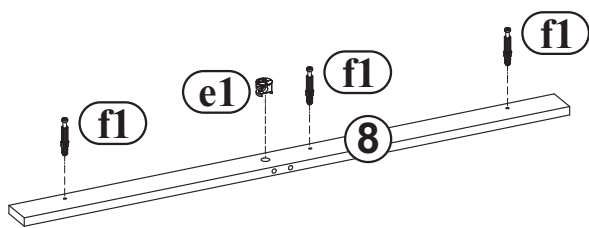
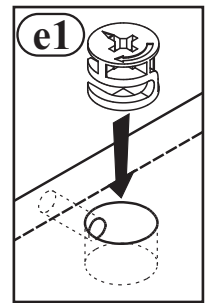
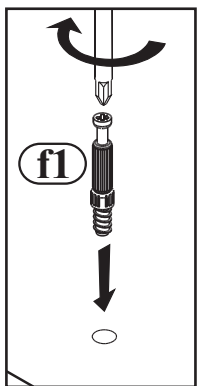
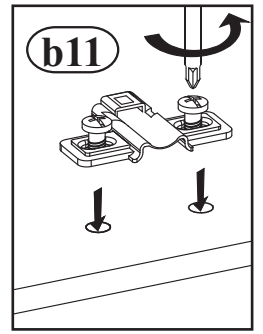
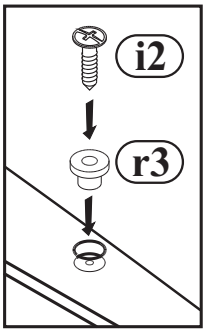
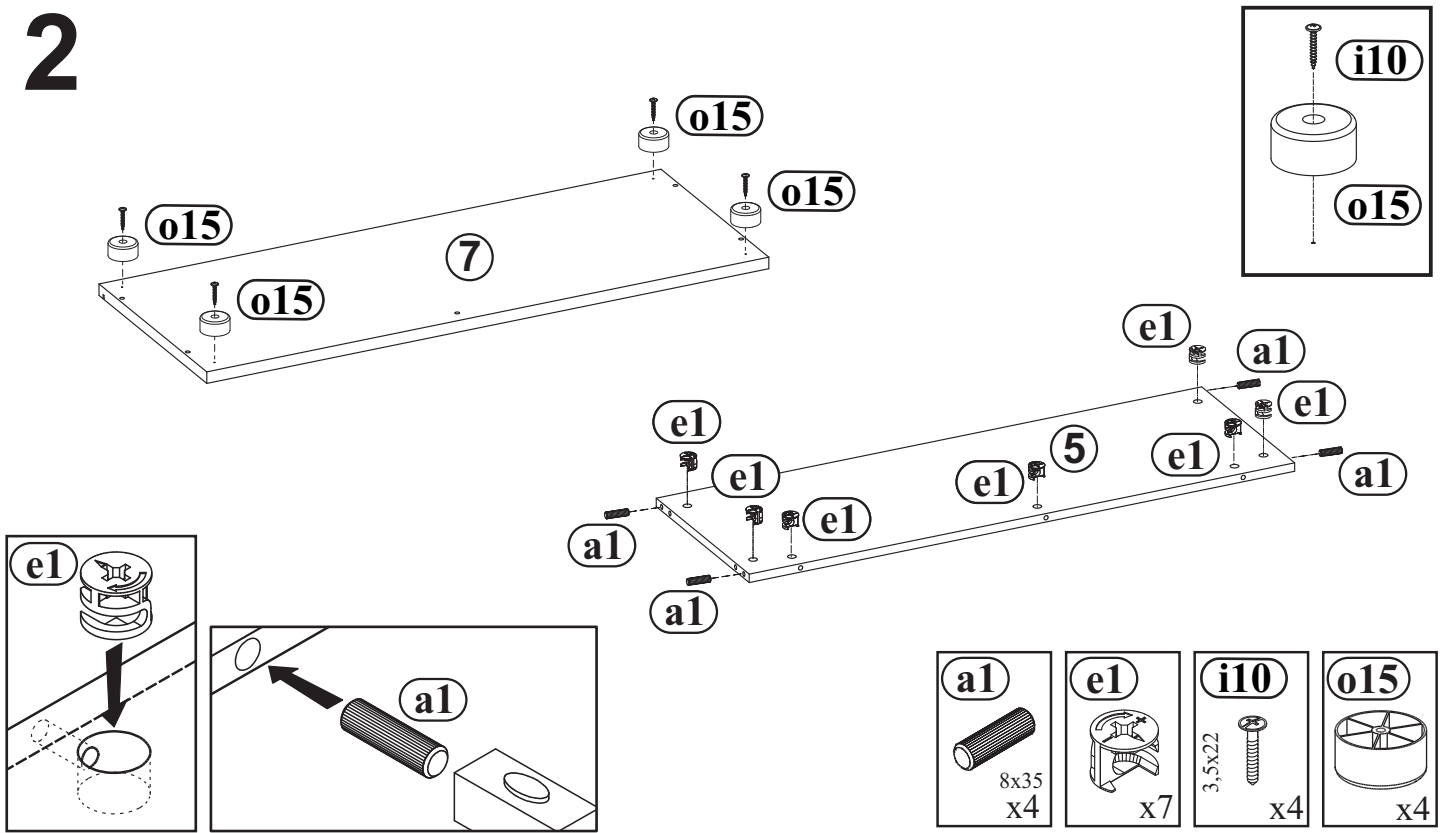

3

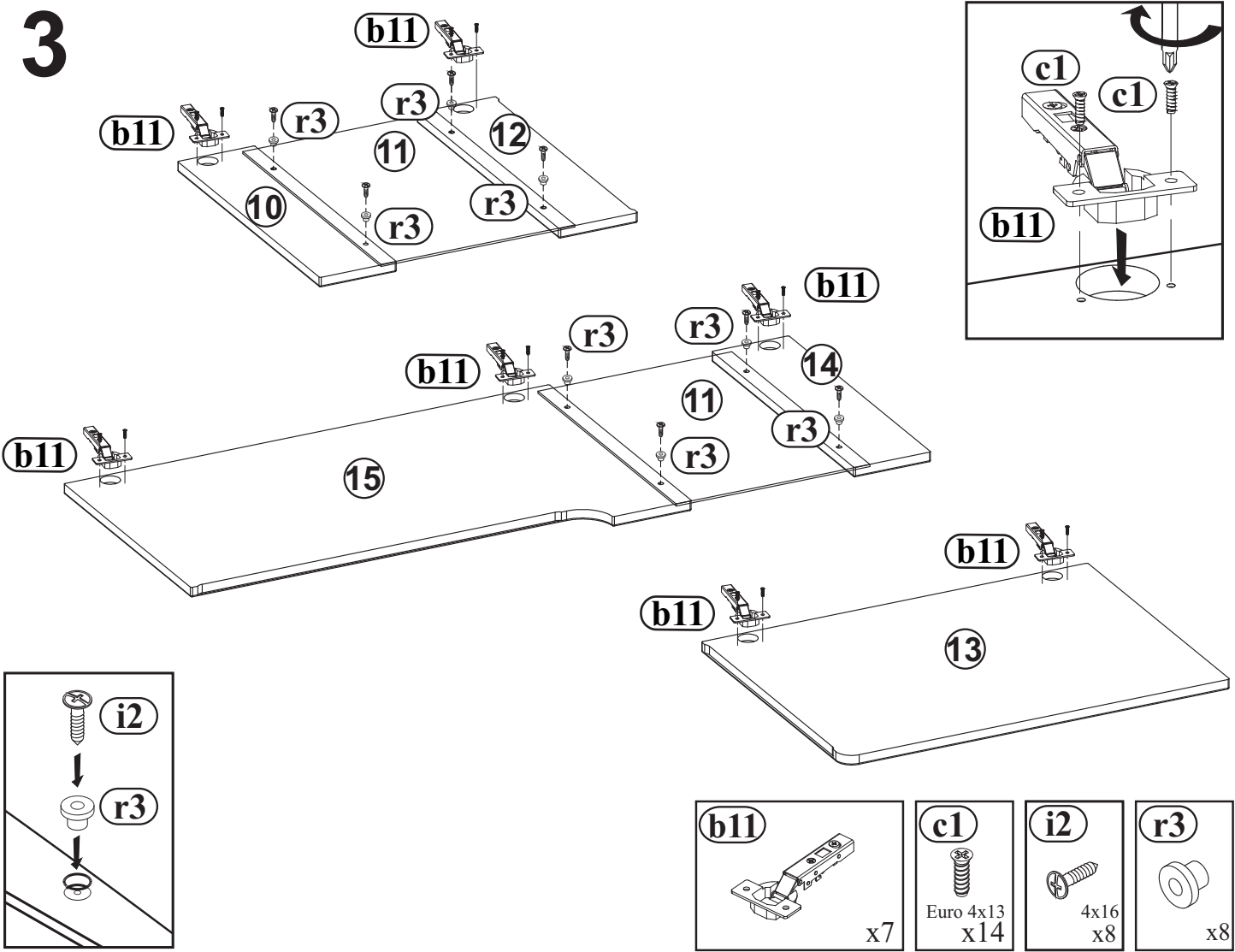

4

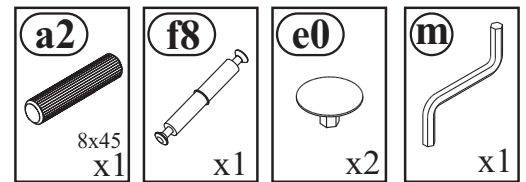
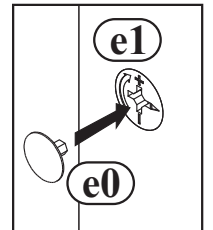
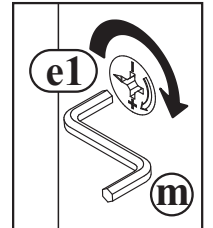
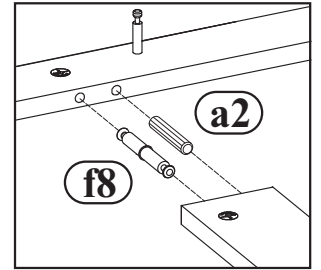
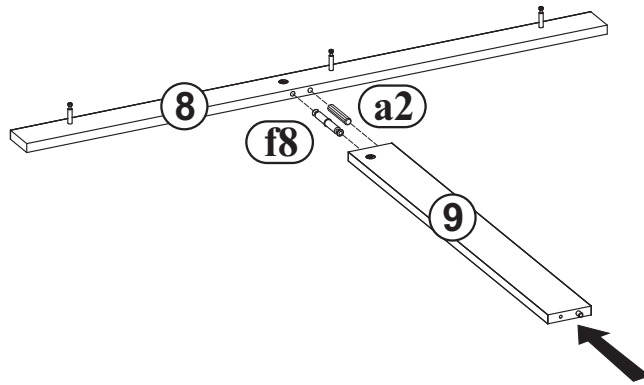

5

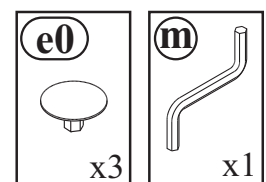
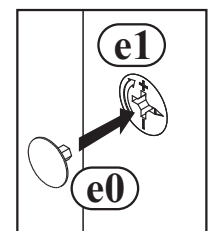
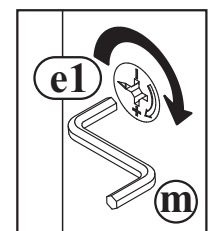
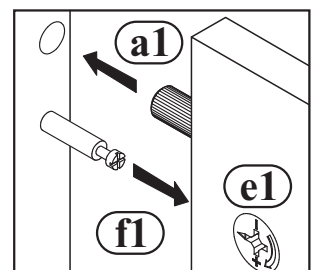
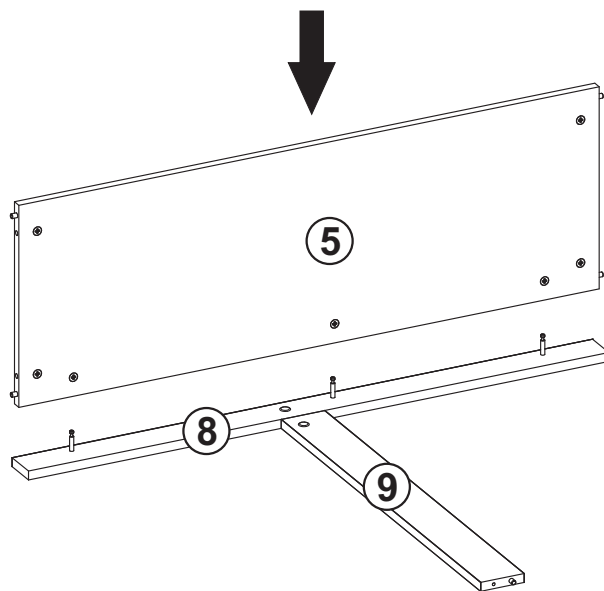

6

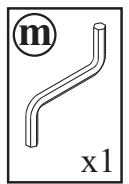
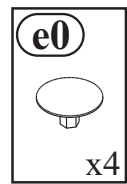
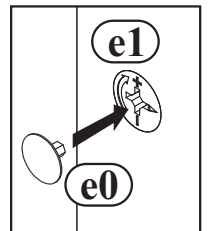
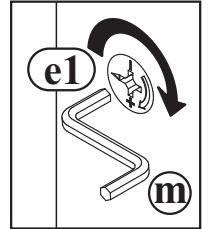
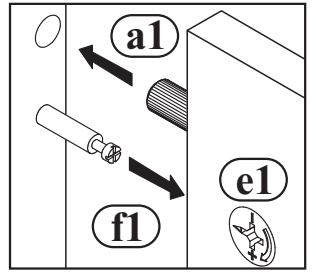
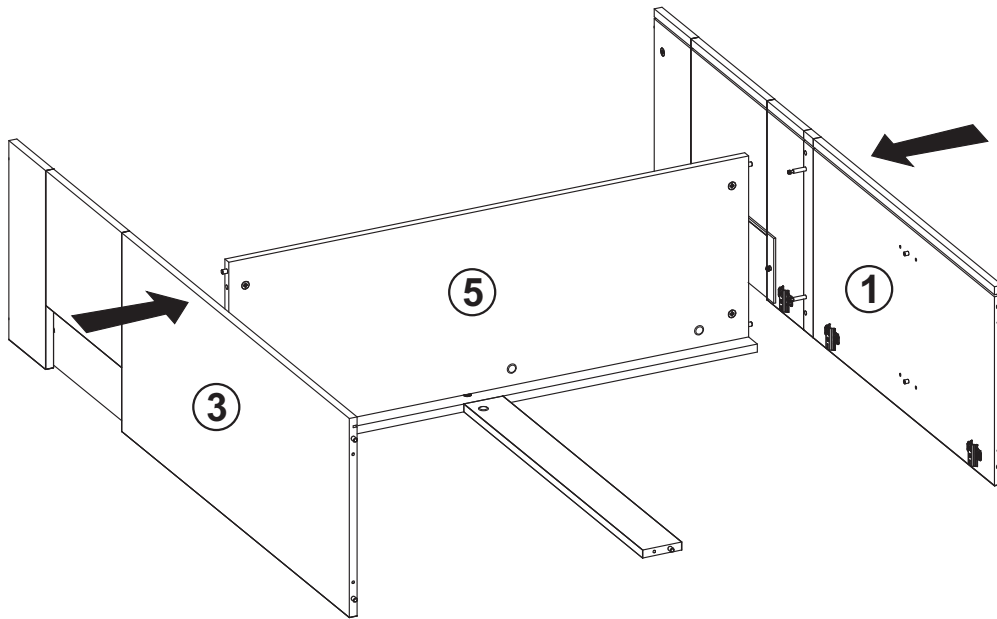

7

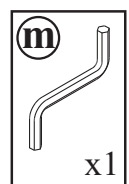
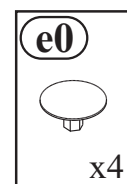
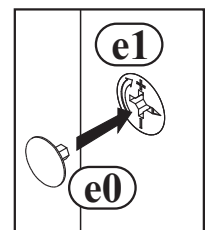
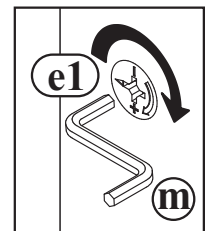
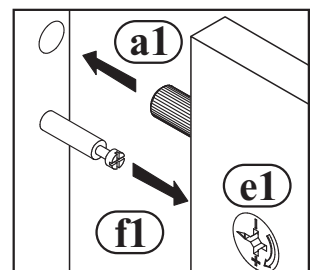
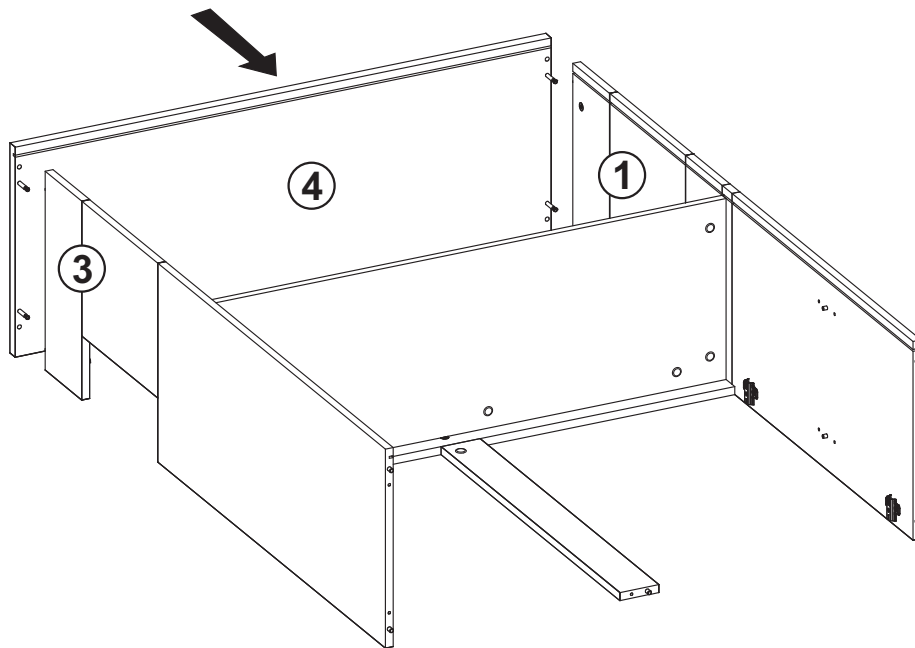

8

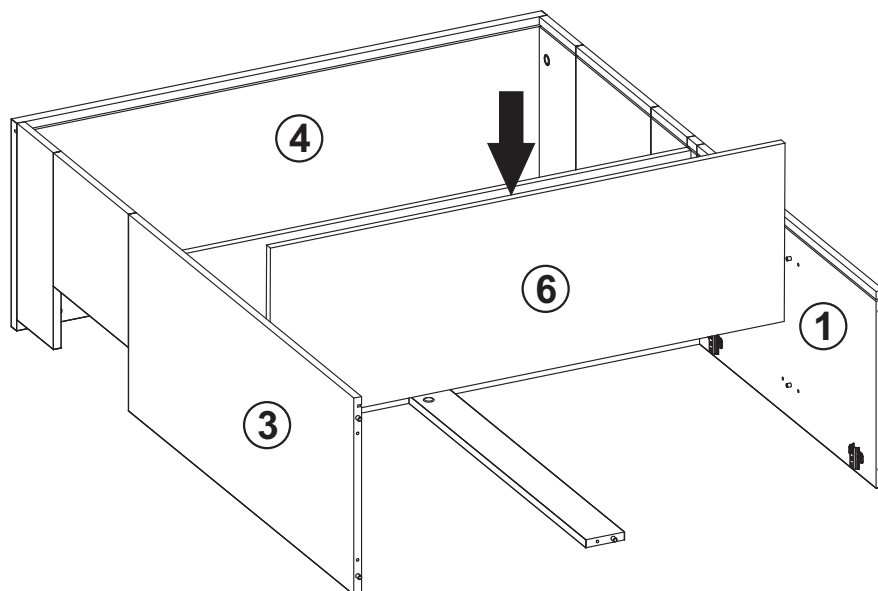

9

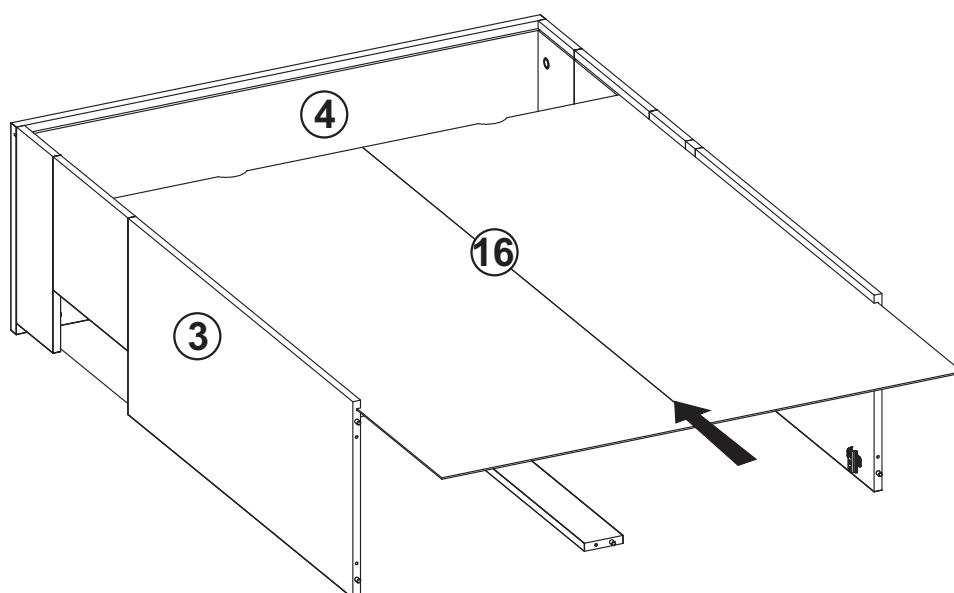

10

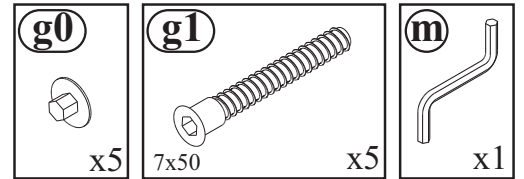
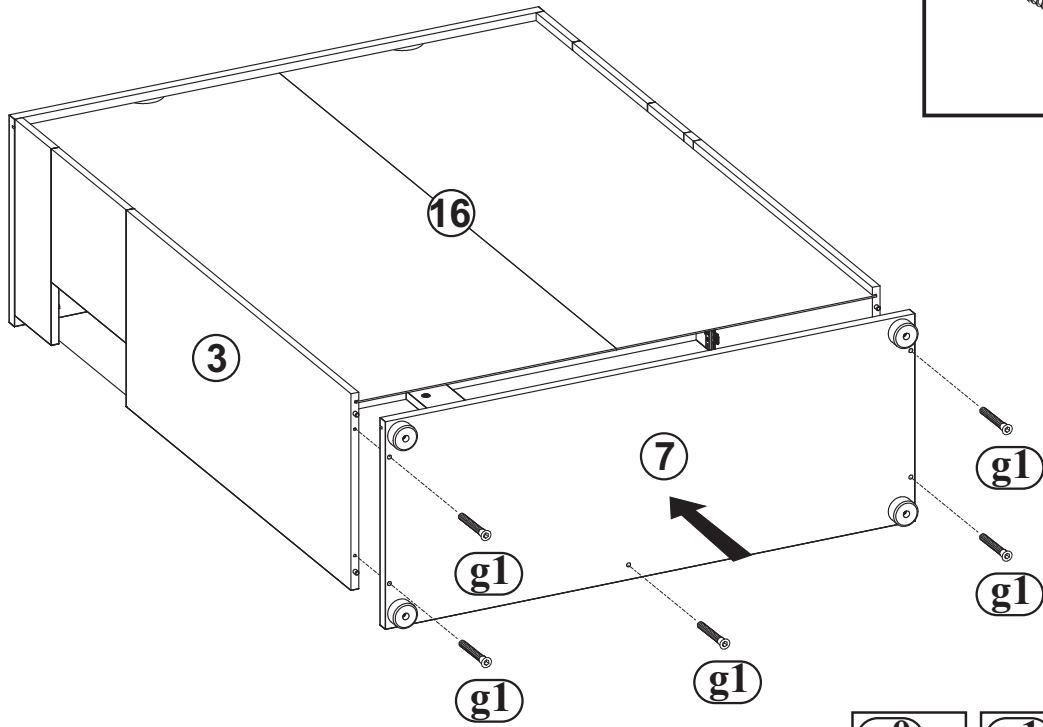

11

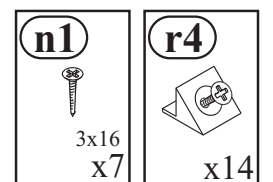
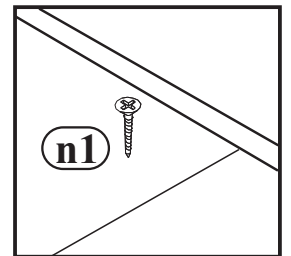
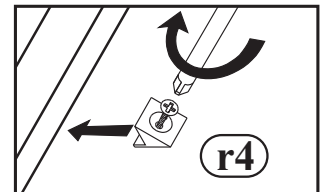
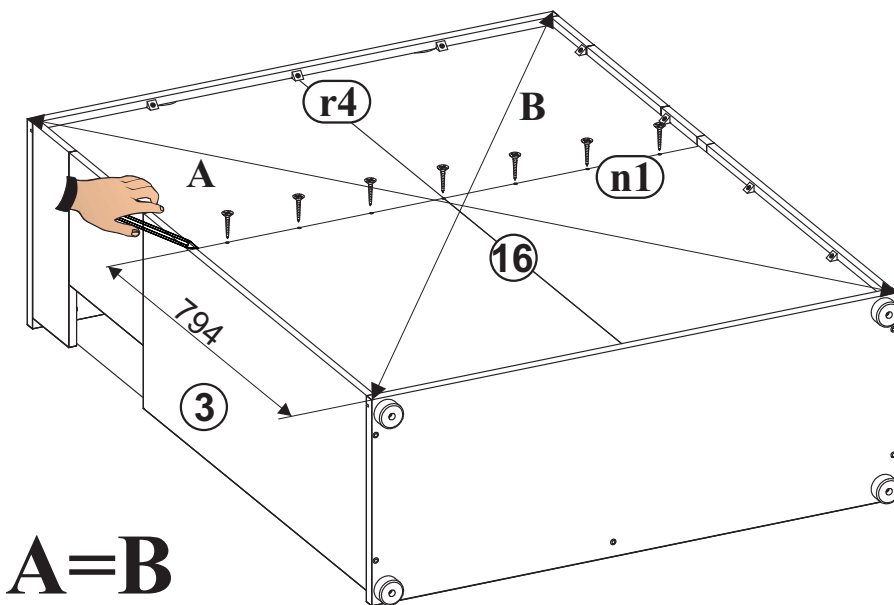

12

